

***GasAlertMicro5***  
***GasAlertMicro5 PID***  
***GasAlertMicro5 IR***

*1, 2, 3, 4, and 5-Gas Detector*

*User Manual*

**BW**  
Technologies  
by Honeywell

## Limited Warranty and Limitation Liability

BW Technologies LP (BW) warrants the product to be free from defects in material and workmanship under normal use and service for a period of two years, beginning on the date of shipment to the buyer. This warranty extends only to the sale of new and unused products to the original buyer. BW's warranty obligation is limited, at BW's option, to refund of the purchase price, repair or replacement of a defective product that is returned to a BW authorized service center within the warranty period. In no event shall BW's liability hereunder exceed the purchase price actually paid by the buyer for the Product.

This warranty does not include:

- a) fuses, disposable batteries or the routine replacement of parts due to the normal wear and tear of the product arising from use;
- b) any product which in BW's opinion, has been misused, altered, neglected or damaged, by accident or abnormal conditions of operation, handling or use;
- c) any damage or defects attributable to repair of the product by any person other than an authorized dealer, or the installation of unapproved parts on the product; or

The obligations set forth in this warranty are conditional on:

- a) proper storage, installation, calibration, use, maintenance and compliance with the product manual instructions and any other applicable recommendations of BW;
- b) the buyer promptly notifying BW of any defect and, if required, promptly making the product available for correction. No goods shall be returned to BW until receipt by the buyer of shipping instructions from BW; and
- c) the right of BW to require that the buyer provide proof of purchase such as the original invoice, bill of sale or packing slip to establish that the product is within the warranty period.

THE BUYER AGREES THAT THIS WARRANTY IS THE BUYER'S SOLE AND EXCLUSIVE REMEDY AND IS IN LIEU OF ALL OTHER WARRANTIES, EXPRESS OR IMPLIED, INCLUDING BUT NOT LIMITED TO ANY IMPLIED WARRANTY OF MERCHANTABILITY OR FITNESS FOR A PARTICULAR PURPOSE. BW SHALL NOT BE LIABLE FOR ANY SPECIAL, INDIRECT, INCIDENTAL, OR BASED ON CONTRACT, TORT OR RELIANCE OR ANY OTHER THEORY.

Since some countries or states do not allow limitation of the term of an implied warranty, or exclusion or limitation of incidental or consequential damages, the limitations and exclusions of this warranty may not apply to every buyer. If any provision of this warranty is held invalid or unenforceable by a court of competent jurisdiction, such holding will not affect the validity or enforceability of any other provision.

BW Technologies by Honeywell  
Corporate Headquarters  
2840 - 2nd Ave. SE  
Calgary, AB  
Canada T2A 7X9

BW Technologies by Honeywell  
America  
3279 West Pioneer Parkway  
Arlington, TX  
USA 76013

BW Technologies by Honeywell  
Europe  
5 Canada Close  
Banbury, Oxfordshire  
United Kingdom OX16 2RT

# Table of Contents

Title	Page
Limited Warranty and Limitation Liability .....	0
Contacting BW Technologies by Honeywell .....	1
Introduction .....	1
Gases Monitored .....	2
Safety Information - Read First.....	2
△ Cautions .....	3
Sensor Poisons and Contaminants .....	6
Getting Started .....	8
Parts of the GasAlertMicro 5/PID/IR .....	9
Screen Elements .....	10
Pushbuttons .....	11
Activating the Detector.....	12
Self-Tests.....	12
Battery Test .....	12
Datalogging (Optional).....	13
Pump Test .....	15
Due-Lock Enabled .....	16
Force Calibration Enabled .....	17
Bump Daily Enabled .....	17
Self-Test Pass .....	19
Self Test Fail.....	19
Battery Test .....	19
Datalogger Operation (Optional).....	19

<b>Title</b>	<b>Page</b>
<b>Deactivating the Detector .....</b>	<b>20</b>
<b>User Options Menu .....</b>	<b>20</b>
Exit User Options Menu .....	21
Options Menu .....	21
Backlight .....	22
Confidence Beep .....	22
Due-Lock .....	22
Latched Alarms .....	22
Passcode Protect .....	23
Safe Display .....	23
Sensor Configuration .....	24
Sensor Enable/Disable .....	25
Span Gas Value .....	26
STEL Period .....	26
TWA Method .....	27
Resolution .....	27
%Vol CO <sub>2</sub> (CO <sub>2</sub> Sensors Only) .....	28
%Vol CH <sub>4</sub> (LEL Sensors Only) .....	28
Correction Factor (CF) .....	28
Automatic Oxygen (O <sub>2</sub> ) Calibration .....	30
Logger Option .....	30
Clock Option .....	31
Language Selection .....	32
Tech Mode .....	32
Sensors .....	33
Initialize .....	34
Force Calibration .....	35

---

<b>Title</b>	<b>Page</b>
Bump Daily .....	35
Stealth Mode.....	36
Sleep Mode.....	36
<b>Alarms .....</b>	<b>37</b>
Gas Exposures Computed .....	40
Viewing Gas Exposures .....	40
Clearing Gas Exposures .....	41
Gas Alarm Setpoints .....	41
Viewing the Alarm Setpoints .....	41
Resetting Gas Alarm Setpoints.....	42
Stopping a Gas Alarm .....	43
Sensor Alarm .....	43
Pump Alarm .....	43
Low Battery Alarm.....	44
Automatic Deactivation Alarm.....	44
<b>Calibration and Setting Alarm Setpoints .....</b>	<b>44</b>
Guidelines .....	44
Diagnostics Testing.....	45
Applying Gas to the Sensors .....	46
Single Gas Calibration Cap .....	46
Calibration Procedure .....	47
Start Calibration .....	48
Auto Zero and Oxygen (O <sub>2</sub> ) Sensor Calibration .....	48
Zero CO <sub>2</sub> (GasAlertMicro 5 IR only) .....	48
Passcode Protect Activated.....	49
Auto Span .....	50
Successful Span .....	52

<b>Title</b>	<b>Page</b>
Setting the Calibration Due Date .....	52
Alarm Setpoints .....	54
Setting the Remaining Alarm Setpoints .....	56
Finish Calibration .....	56
Verification .....	56
Unsuccessful Span .....	57
<b>Attaching the Accessories .....</b>	<b>59</b>
Installing the Pump Module.....	59
Replacing the Pump Filter.....	60
Replacing the Pump Nozzle.....	61
Attaching the Auxiliary Filter .....	61
Attaching the Sample Probe .....	63
<b>Datalogger .....</b>	<b>64</b>
<b>MMC/SD Card Compatibility.....</b>	<b>64</b>
Inserting the MMC/SD Card.....	64
<b>MMC/SD Card Troubleshooting .....</b>	<b>65</b>
Restoring Datalog Files.....	66
Reformatting the MMC/SD Card .....	67
<b>Import Datalogs to Fleet Manager II .....</b>	<b>68</b>
Minimum PC Requirements .....	68
Importing from MicroDock II to Fleet Manager II.....	68
Import to Fleet Manager II Using a Card Reader .....	68
<b>View Datalog Files in Spreadsheets .....</b>	<b>69</b>
Example of a Datalog Spreadsheet .....	70
<b>Maintenance .....</b>	<b>73</b>
Battery Cautions .....	73
Charging the Battery .....	73

<b>Title</b>	<b>Page</b>
Replacing the Alkaline Batteries .....	74
Replacing the Lithium Battery Pack .....	75
Replacing a Sensor or Sensor Filter .....	75
Photoionization Detector (PID) .....	77
Clean or Replace the Lamp .....	77
Replace the Lamp.....	78
Replace the Electrode Stack .....	78
<b>Troubleshooting .....</b>	<b>79</b>
<b>Replacement Parts and Accessories .....</b>	<b>85</b>
<b>Specifications .....</b>	<b>87</b>
General Specifications for Datalogger Units .....	90
GasAlertMicro 5/PID/IR Downloadable Datalogger .....	90
<b>PID Correction Factor (CF) Library .....</b>	<b>91</b>





# List of Figures

Figure	Title	Page
1.	Parts of the GasAlertMicro 5/PID/IR.....	9
2.	Screen Elements .....	10
3.	Applying Gas to the Sensors.....	46
4.	Single Gas Calibration Cap .....	47
5.	Removing the Single Gas Calibration Cap.....	47
6.	Installing the Pump Module .....	59
7.	Replacing the Pump Filter .....	60
8.	Replacing the Pump Nozzle .....	61
9.	Attaching the Auxiliary Filter.....	61
10.	Attaching the Filter Cord.....	62
11.	Attaching the Sample Probe.....	63
12.	Inserting/Removing the MMC/SD Card .....	65
13.	Replacing the Alkaline Batteries.....	74
14.	Replacing the Lithium Battery Pack .....	75
15.	Replacing a Sensor or Sensor Filter .....	76
16.	Parts of the PID .....	77



# List of Tables

Table	Title	Page
1.	Gases Monitored .....	2
2.	Sensor Poisons and Contaminants .....	6
3.	International Symbols .....	7
4.	Parts of the GasAlertMicro 5/PID/IR .....	9
5.	Screen Elements .....	10
6.	Pushbutton .....	11
7.	Alarms .....	37
8.	Computed Gas Exposures .....	40
9.	Gas Alarm Setpoints .....	41
10.	OSHA Sample Factory Alarm Setpoints.....	42
11.	Applying Gas to the Sensors .....	46
12.	Single Gas Calibration Cap .....	47
13.	Time Required to Span .....	51
14.	Installing the Pump Module .....	59
15.	Datalog Spreadsheet Example.....	70
16.	Datalog Status Codes .....	71
17.	Datalog Gas and Correction Factor Sensor Codes.....	72
18.	Replacing the Alkaline Batteries.....	74
19.	Replacing a Sensor or Sensor Filter .....	76
20.	Parts of the PID sensor .....	77
21.	Troubleshooting.....	79
22.	Replacement Parts and Accessories .....	85
23.	PID Corrections Factor (CF) Library.....	91



# GasAlertMicro 5/PID/IR

## Contacting BW Technologies by Honeywell

To contact BW Technologies by Honeywell, call

USA: 1-888-749-8878

Canada: 1-800-663-4164

Europe: +44 (0) 1295 700300

Other countries: +1-403-248-9226

Address correspondence to

BW Technologies by Honeywell

2840 – 2 Avenue S.E.

Calgary, AB T2A 7X9

CANADA

Email: [info@gasmonitors.com](mailto:info@gasmonitors.com)

Website: [www.gasmonitors.com](http://www.gasmonitors.com)

ISO 9001

## Introduction

### Warning

To ensure personal safety, read the [Safety Information - Read First](#) and Cautions before using the detector.

The GasAlertMicro 5, GasAlertMicro 5 PID, and GasAlertMicro 5 IR gas detectors (“the detector”) warn of hazardous gas at levels above user-defined alarm setpoints.

The detector is a personal safety device. It is your responsibility to respond properly to the alarm.

### Note

*Unless reference is made to a specific detector model, the GasAlertMicro 5, GasAlertMicro 5 PID, and GasAlertMicro 5 IR detectors are referred to as GasAlertMicro 5/PID/IR.*

Refer to [Gases Monitored](#) prior to operating the detector.

## Gases Monitored

The following table lists the gases that are monitored by the detector.

**Table 1. Gases Monitored**

Gas Detected	Unit of Measure
Oxygen (O <sub>2</sub> )	% volume
Combustible gases (LEL)	a) percent of lower explosive limit (%LEL) b) percent by volume methane 0-5.0% v/v
Carbon monoxide (CO)	parts per million (ppm)
Hydrogen sulfide (H <sub>2</sub> S)	parts per million (ppm)
Phosphine (PH <sub>3</sub> )	parts per million (ppm)
Sulfur oxide (SO <sub>2</sub> )	parts per million (ppm)
Chlorine (Cl <sub>2</sub> )	parts per million (ppm)
Ammonia (NH <sub>3</sub> )	parts per million (ppm)
Nitrogen dioxide (NO <sub>2</sub> )	parts per million (ppm)
Hydrogen cyanide (HCN)	parts per million (ppm)
Chlorine dioxide (ClO <sub>2</sub> )	parts per million (ppm)
Ozone (O <sub>3</sub> )	parts per million (ppm)
Volatile organic compounds (VOC)	parts per million (ppm)
Carbon dioxide (CO <sub>2</sub> )	parts per million or %vol CO <sub>2</sub>

**CAUTION: FOR SAFETY REASONS, THIS EQUIPMENT MUST BE OPERATED AND SERVICED BY QUALIFIED PERSONNEL ONLY. READ AND UNDERSTAND THIS USER MANUAL COMPLETELY BEFORE OPERATING AND SERVICING.**

## Safety Information - Read First

Use the detector only as specified in this user manual, otherwise the protection provided by the detector may be impaired.

International symbols used on the detector and in this user manual are defined in [Table 3](#).

Read the Cautions on the following pages before using the detector.



**Warning**

**This instrument contains batteries. Do not mix with the solid waste stream. Spent batteries must be disposed of by a qualified recycler or hazardous materials handler.**

**Dispose of lithium cells immediately. Do not disassemble and do not dispose of in fire. Do not mix with the solid waste stream. Spent batteries must be disposed of by a qualified recycler or hazardous materials handler.**

### ⚠ Cautions

- **Warning:** Substitution of components may impair Intrinsic Safety.
- **Caution:** For safety reasons, this equipment must be operated and serviced by qualified personnel only. Read and understand this user manual completely before operating or servicing.
- Do not use the detector if it is damaged. Inspect the detector before using. Look for cracks and/or missing parts.
- If the detector is damaged or parts are missing, contact [BW Technologies by Honeywell](#) immediately.
- Use only sensor(s) that are specifically designed for the GasAlertMicro 5/PID/IR detectors. Refer to [Replacement Parts and Accessories](#).
- Calibrate the detector before first-time use and then on a regular schedule, depending on use and sensor exposure to poisons and contaminants. Sensors must be calibrated regularly and at least once every 180 days (6 months).
- BW recommends to bump test the sensors, before each day's use, to confirm their ability to respond to gas by exposing the detector to a gas concentration that exceeds the alarm setpoints. Manually verify that the audible and visual alarms are activated. Calibrate if the readings are not within the specified limits.
- BW recommends the combustible sensor be checked with a known concentration of calibration gas after any known exposure to catalyst contaminants/poisons (sulfur compounds, silicon vapors, halogenated compounds, etc).
- The combustible sensor is factory calibrated to 50% LEL methane. If monitoring a different combustible gas in the % LEL range, calibrate the sensor using the appropriate gas.
- **Warning:** High off-scale LEL readings may indicate an explosive concentration.
- Only the combustible gas detection portion of this instrument has been assessed for performance by CSA International.
- Protect the combustible sensor from exposure to lead compounds, silicones, and chlorinated hydrocarbons. Although certain organic vapors (such as leaded gasoline and halogenated hydrocarbons) may temporarily inhibit sensor performance, in most cases, the sensor will recover after calibration.
- Before using common products around sensors, refer to [Sensor Poisons and Contaminants](#).

**⚠ Cautions**

- Any rapid up-scaling reading followed by a declining or erratic reading may indicate a gas concentration beyond upper scale limit, which may be hazardous.
- Calibrate only in a safe area that is free of hazardous gas, in an atmosphere of 20.9% oxygen.
- Use only BW approved batteries for the GasAlertMicro 5/PID/IR detectors. Refer to [Replacement Parts and Accessories](#).
- Charge the detector before first-time use. BW recommends the detector be charged after every workday.
- Charge the battery pack immediately when a low battery alarm occurs.
- Read and adhere to the battery cautions provided in [Battery Cautions](#).
- Charge the GasAlertMicro 5/PID/IR batteries using the recommended charging adapter only. Do not use any other charging adapter. Failure to adhere to this caution can lead to fire and/or explosion.
- Read and adhere to all instructions in the charger user manual. Failure to do so can result in fire, electrical shock, personal injury, and/or property damage.
- Extended exposure of the GasAlertMicro 5/PID/IR detectors to certain concentrations of combustible gases and air may stress a detector element, which can seriously affect its performance. If an alarm occurs due to high concentration of combustible gases, recalibration should be performed, or if needed, the sensor replaced.
- Protect the PID sensor from exposure to silicone vapors.
- When calibrating O<sub>3</sub> and ClO<sub>2</sub> sensors that are located in the Toxic 2 sensor position, a single gas calibration cap must be used to ensure accurate calibration. For more information, refer to [Single Gas Calibration Cap](#).
- Replace the CO<sub>2</sub> sensor only in a safe area that is free of hazardous gas.
- The optional pump (M5-PUMP) is certified for use with the GasAlertMicro 5/PID/IR detectors only.
- Do not immerse the detector in liquids.



**⚠ Cautions**

- Do not test the combustible sensor's response with a butane cigarette lighter; doing so will damage the sensor.
- Do not expose the detector to electrical shock or severe continuous mechanical shock.
- Do not attempt to disassemble, adjust, or service the detector unless instructions for that procedure are provided in the user manual and/or that part is listed as a replacement part. Use only BW Technologies by Honeywell [Replacement Parts and Accessories](#).
- The detector warranty is void if customer, personnel, or third parties damage the detector during repair attempts. Repair attempts made by non-BW Technologies by Honeywell repair/service personnel voids this warranty.

**Lithium Battery Packs**

- **Warning:** The lithium battery (M5-BAT08) may present a risk of fire or chemical burn hazard if misused. Do not disassemble, heat above 212°F (100°C), or incinerate.
- Do not use any other lithium batteries with the GasAlertMicro 5/PID/IR detectors. Use of any other cell can cause fire and/or explosion. To order and replace the M5-BAT08 battery, refer to [Replacement Parts and Accessories](#).
- **Warning:** Lithium polymer cells exposed to heat at 266°F (130°C) for 10 minutes can cause fire and/or explosion.
- Dispose of used lithium cells immediately. Do not disassemble and do not dispose of in fire. Do not mix with the solid waste stream. Spent batteries must be disposed of by a qualified recycler or hazardous materials handler.
- Keep lithium cells away from children.

## **Sensor Poisons and Contaminants**

Several cleaners, solvents, and lubricants can contaminate and cause permanent damage to sensors. Before using cleaners, solvents, and lubricants in close proximity to the detector sensors, read and adhere to the following caution and table.

### **⚠ Caution**

**Use only the following BW Technologies by Honeywell recommended products and procedures:**



- **Use water based cleaners.**
- **Use non-alcohol based cleaners.**
- **Clean the exterior with a soft, damp cloth.**
- **Do not use soaps, polishes, or solvents.**

The following table lists common products to avoid using around sensors.

**Table 2. Sensor Poisons and Contaminants**

<b>Cleaners and Lubricants</b>	<b>Silicones</b>	<b>Aerosols</b>
Brake cleaners	Silicone cleaners and protectants	Bug repellents and sprays
Lubricants	Silicone based adhesives, sealants, and gels	Lubricants
Rust inhibitors	Hand/body and medicinal creams that contain silicone	Rust inhibitors
Window and glass cleaners	Tissues containing silicone	Window and glass cleaners
Dishsoaps	Mold releasing agents	
Citrus based cleaners	Polishes	
Alcohol based cleaners		
Hand sanitizers		
Anionic detergents		
Methanol (fuels and antifreezes)		

**Table 3. International Symbols**

<b>Symbol</b>	<b>Description</b>
	Approved to both U.S. and Canadian Standards by CSA International
	European Explosives Protection
	Conforms to European Union Directives
<b>ATEX</b>	Conforms to European ATEX Directives
<b>IECEx</b>	International Electrotechnical Commission Scheme for Certification to Standards for Electrical Equipment for Explosive Atmospheres

## **Getting Started**

The list below provides the standard items included with the detector. If the detector is damaged or parts are missing, contact the place of purchase immediately.

- Batteries: Three replaceable alkaline cells with battery pack, or one rechargeable lithium battery pack
- Sensors: O<sub>2</sub>, combustible (LEL), toxic, H<sub>2</sub>S/CO (TwinTox sensor), PID, or CO<sub>2</sub>
- Calibration cap and hose
- Single gas calibration cap
- Screwdriver
- Quick reference guide
- Quick reference card
- User manual and training on CD-ROM
- Fleet Manager II (if applicable)

To order parts, refer to [Replacement Parts and Accessories](#).

The detector is shipped with the sensors, and battery packs installed.

To replace sensors, the pump, or the battery pack, refer to [Replacement Parts and Accessories](#).

To become oriented with the features and functions of the detector, refer to the following figures and tables:

- [Figure 1](#), and [Table 4](#), describe the detector's components.
- [Figure 2](#), and [Table 5](#), describe the detector's screen elements.
- [Table 6](#), describes the detector's pushbutton.

**Parts of the GasAlertMicro 5/PID/IR**

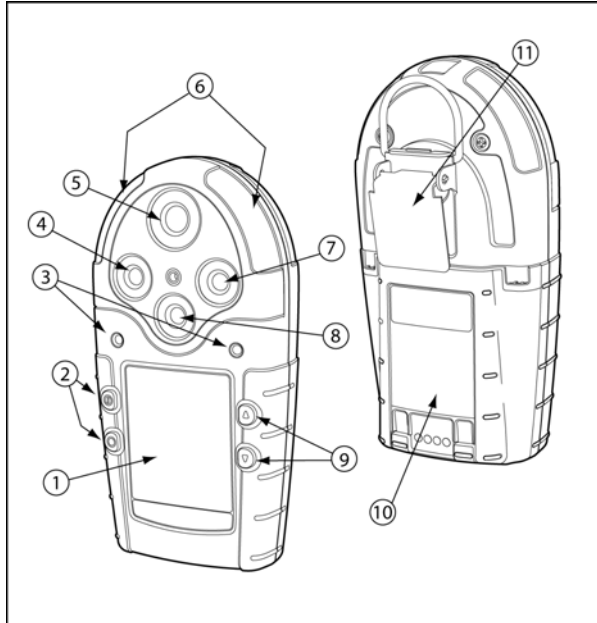
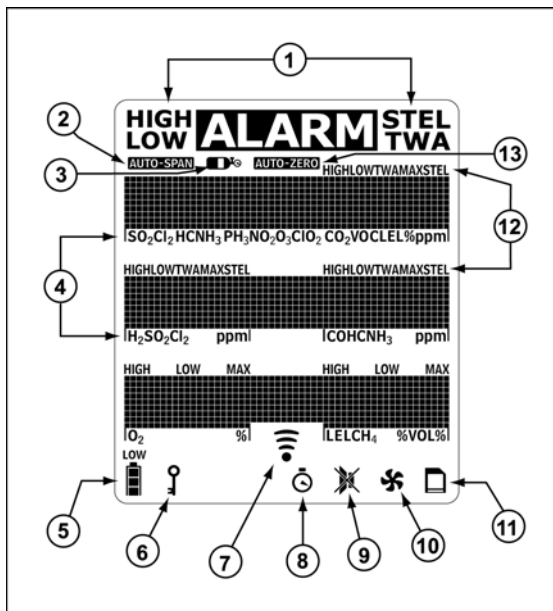

**Figure 1. Parts of the GasAlertMicro 5/PID/IR**

**Table 4. Parts of the GasAlertMicro 5/PID/IR**

Item	Description
1	Liquid crystal display (LCD)
2	Pushbuttons
3	Audible alarms
4	Toxic 2 sensor
5	Toxic 1/PID sensor (Micro 5 PID) or Toxic 1/IR (CO <sub>2</sub> ) sensor (Micro 5 IR)
6	Visual alarm indicators (LEDs)
7	LEL sensor
8	Oxygen sensor
9	Pushbuttons
10	Battery pack
11	Alligator clip

## Screen Elements



**Figure 2. Screen Elements**

*Note*

















*If enabled, the backlight automatically activates for 8 seconds when there is an alarm condition and whenever there is insufficient light to view the LCD. Any pushbutton reactivates the backlight in low light conditions.*

**Table 5. Screen Elements**

Item	Description
1	Alarm condition
2	Automatically span sensor
3	Gas cylinder
4	Gas type
5	Battery life indicator
6	Passcode lock
7	Data transmission
8	Clock
9	Stealth mode
10	Pump indicator (optional)
11	MMC indicator (optional)
12	Alarm condition (low, high, TWA, STEL, or multi alarm) or view TWA, STEL and peak (MAX) gas exposures
13	Automatically zero sensor

## Pushbuttons

**Table 6. Pushbutton**

Pushbutton	Description
	<ul style="list-style-type: none"> <li>• To activate the detector press .</li> <li>• To deactivate the detector, press and hold  until the countdown is complete.</li> </ul>
	<ul style="list-style-type: none"> <li>• To increment the displayed value or scroll up, press .</li> <li>• To enter the user options menu, press and hold  and  simultaneously until the countdown is complete.</li> <li>• To clear the TWA, STEL, and peak (MAX) gas exposure readings, press and hold  and  simultaneously until the countdown is complete.</li> <li>• To view the date and time, alarm setpoints (TWA, STEL, low, high) of all sensors, and the LEL/PID correction factor (if applicable) press .</li> </ul>
	<ul style="list-style-type: none"> <li>• To decrement the displayed value or scroll down, press .</li> <li>• To initiate calibration and to define alarm setpoints, press and hold  and  simultaneously until the countdown is complete.</li> </ul>
	<ul style="list-style-type: none"> <li>• To view the TWA, STEL, and peak (MAX) gas exposure readings, press .</li> <li>• To acknowledge latched alarms, press .</li> </ul>

## Activating the Detector

If using the pump module, attach it and the pump accessories prior to activating the detector.

For illustrations and procedures, refer to the following:

- [Installing the Pump Module](#).
- [Attaching the Sample Probe](#)
- [Replacing the Pump Filter](#)
- [Replacing the Pump Nozzle](#)
- [Attaching the Auxiliary Filter](#)

### Note

*Only activate the detector in a safe atmosphere that is free of hazardous gas in an atmosphere of 20.9% oxygen.*

To activate the detector, press .

## Self-Tests

When the detector is activated, it performs several self-tests. Confirm the following tests occur.

### Note

*If an error message displays during the self-test, refer to [Troubleshooting](#).*

## Battery Test

The detector performs a battery test during startup. If the battery has insufficient power to operate, the following screen displays before deactivating.

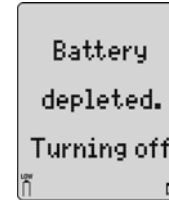

Replace the batteries and reactivate the detector.

1. All of the LCD elements display simultaneously as the detector beeps, flashes, vibrates, and briefly activates the back-light.

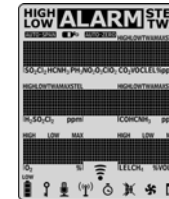



2. The version and serial number of the detector displays.

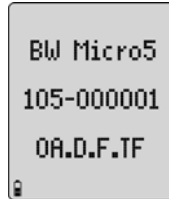

3. The date and time displays.

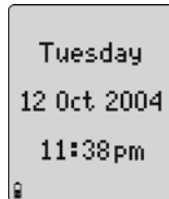

### *Datalogging (Optional)*

4. If the detector is a datalogging unit, it determines if
- a MultiMediaCard (MMC) or Secure Digital (SD) card is inserted,
  - the detector can communicate with the card,
  - the detector supports the size of the card, and
  - the card requires formatting.

### *Note*

*If there is a problem with the MMC/SD card, **Datalogger disabled** displays. The detector then automatically continues with the self-test.*

If the card requires formatting, the following screen displays as the card is automatically formatted.

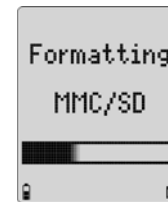

5. The detector then runs a self-test to verify the sensors and power supply are operating correctly.



**Self-test Successful:** If successful, the following screen displays.

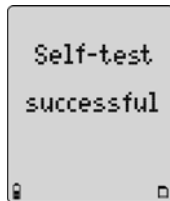

**Self-test Unsuccessful:** If a sensor fails the self-test, a warning displays indicating which sensor(s) has failed.

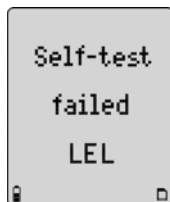

6. If correction factors are set in the user options, the LEL or PID (custom) correction factors display.

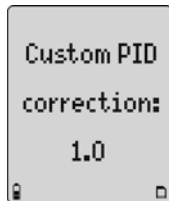
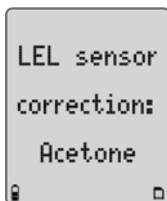

7. The TWA, STEL, low, and high alarm setpoints then display in the following order (left to right).

TWA

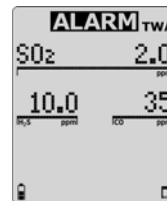

STEL

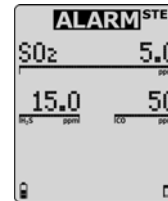

Low

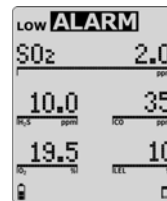

High

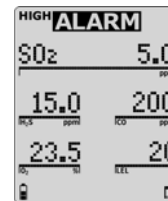

Note

The alarm setpoints may vary by region. Refer to [Resetting Gas Alarm Setpoints](#).

### Pump Test

8. If the pump module is attached to the detector, the following screens display.

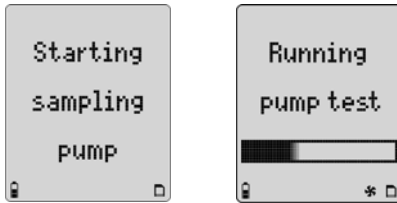

When the following screen displays, block the pump inlet.

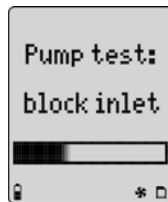

If the pump inlet is not blocked within 10 seconds or the pump test fails, the following screens display.



If  is not pressed or the pump is not removed within 25 seconds, the detector performs the pump test again.

#### Note

The pump may require a new filter. Refer to [Replacing the Pump Filter](#).

If the pump alarm persists, remove the battery pack to deactivate the detector and then refer to the "Pump Operation" section of [Troubleshooting](#).

If the pump test is successful, the following screen displays and the self-test continues.

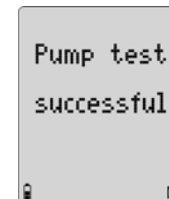

9. Unless disabled in user options, the oxygen (O<sub>2</sub>) sensor is calibrated automatically.

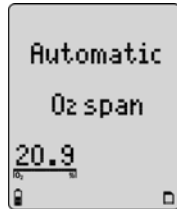

If the calibration is successful, the detector beeps twice.

*Note*

*If the automatic O<sub>2</sub> calibration feature has been disabled, **Automatic O<sub>2</sub> span disabled** displays.*

10. The number of days remaining before calibration is due displays for all sensors.

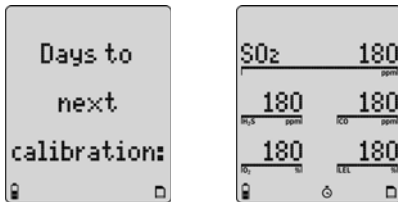

If any sensor is over due for calibration, the LCD displays the name of the sensor and the number of days past due.

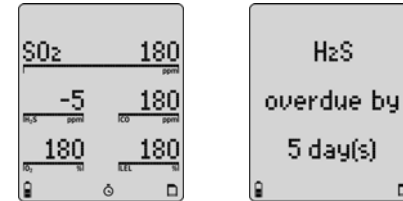

*Due-Lock Enabled*

The **Due-lock** option ensures that a passcode must be entered when calibration is past due, otherwise the detector automatically deactivates.

11. If **Due-Lock** is enabled in the user options, the following screen displays.

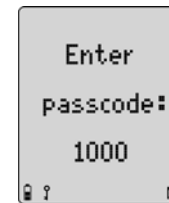

Enter the correct passcode and press  to confirm.

*Note*

*If any sensor is overdue,  displays continually until calibration is performed.*

If no passcode is entered, or it is entered incorrectly, the following screen displays.

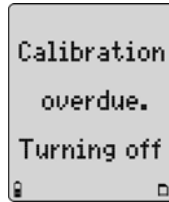

To enable/disable this option, refer to [Due-Lock](#) in the user options menu. Also refer to [Passcode Protect](#).

#### *Force Calibration Enabled*

12. If **Force cal** (force calibration) is enabled in tech mode, calibration is mandatory before the detector enters normal operation.

Refer to [Force Calibration](#) in [Tech Mode](#) to enable/disable, and refer to [Calibration Procedure](#) to calibrate.

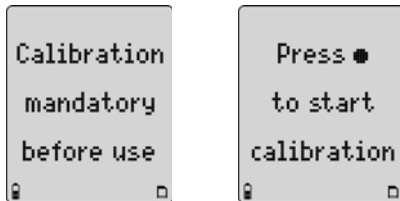

If ○ is not pressed to start calibration, the following screen displays and the detector deactivates.

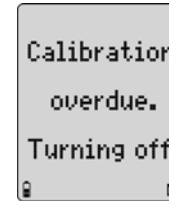

#### *Bump Daily Enabled*

#### **⚠ Caution**

**BW recommends that a bump test to all sensors be performed every 24 hours prior to the beginning of the work shift.**

13. If **Bmp Daily** (bump daily) is enabled in tech mode, the following screens display.

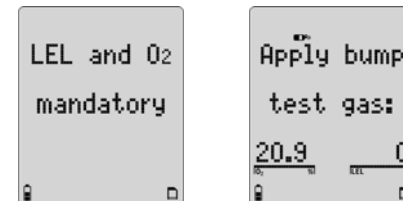

If a bump test of the LEL and O<sub>2</sub> sensor is not performed, the detector will deactivate.

Apply the LEL gas and then apply the O<sub>2</sub> (a higher or lower percentage than the default 20.9%, such as 18% O<sub>2</sub>).

**Successful Bump Test:** If the bump test passes, the following screens display.



The detector waits for the sensor(s) to clear (30 seconds) and then enters normal operation.

**Unsuccessful Bump Test:** If the bump test is unsuccessful or the bump test is not performed, the following screen displays and the detector deactivates.

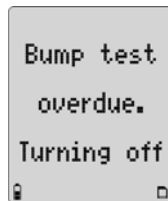

If additional sensors require a bump test but are not mandatory, the following screens display.

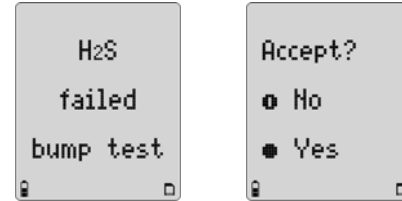

Press  **Yes** to accept and proceed to normal operation.

Or

If  **No** is pressed, or no buttons are pressed, the sensor(s) that is past due displays as **FAIL** when the detector enters normal operation. In the following screen example, only the SO<sub>2</sub>, CO, and O<sub>2</sub> sensors are operational.

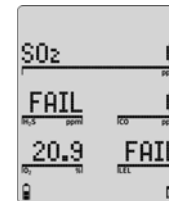

The self-test is now complete.

### **Self-Test Pass**

If the detector passes the self-test, it enters normal operation and displays the ambient gas readings.

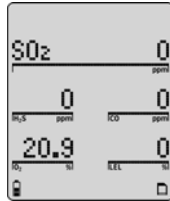

The detector begins recording the peak (MAX) gas exposure and calculating the short-term exposure level (STEL) and time-weighted average (TWA) exposures.

### **Self Test Fail**

If a sensor fails, **FAIL** flashes above that sensor on the normal operation screen. For possible problems and solutions, refer to [Troubleshooting](#).

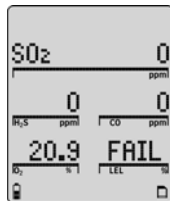

### **Battery Test**

The batteries are tested when the detector is activated and continuously thereafter. The battery power icon displays continually during normal operation. If battery power is low, <sup>LOW</sup>  flashes.

### **Datalogger Operation (Optional)**

#### **⚠ Caution**

**Do not remove the battery pack while the detector is activated. Doing so will prevent the datalogger from logging correctly.**

Datalogger operation is automatic and requires no settings. During normal operation the card is tested every 20 seconds.

#### *Note*

*The MMC/SD card icon () displays continuously on the LCD when the card is inserted. The card is not required for operation; however, if the card is not inserted the detector will not record data.*

## **Deactivating the Detector**

To deactivate the detector, press and hold **Ⓢ** while it beeps and flashes to the corresponding countdown.

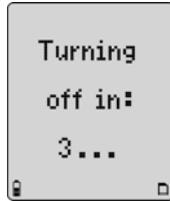

At the end of the countdown, the detector emits an extended beep and flash then displays **0** before deactivating.

### *Note*

*If **Ⓢ** is not held down for the complete countdown, the detector remains activated.*

## **User Options Menu**

If the detector is passcode protected, a passcode must be entered to access the user options menu. For more information, refer to [Passcode Protect](#).

The available user options are as follows:

1. **Exit**
2. **Options:** Backlight, confidence beep, due-lock, latch, passcode, and safe mode.
3. **Sensors:** Sensor enable/disable, span gas, STEL period, TWA method, resolution, % vol CH<sub>4</sub>, correction factor, automatic O<sub>2</sub> calibration, and % vol CO<sub>2</sub>, (CO<sub>2</sub> sensor only)
4. **Logger**
5. **Clock**
6. **Language:** English, French, German, Spanish, and Portuguese.
7. **Tech mode:** Sensors, initialize, forced calibration, daily bump test, stealth, and zero level (CO<sub>2</sub> sensor only).

### *Note*

***Tech mode** is not visible in the user options menu. To access this option, refer to [Tech Mode](#).*



1. To enter the user options menu, press and hold ▲ and ▼ simultaneously as the detector beeps and flashes to the corresponding countdown.

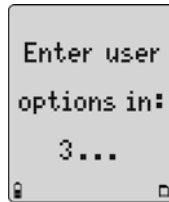

▲ and ▼ must be held down for the entire countdown to access the user options menu.

When the countdown is complete, the revision/serial number screen displays followed by the options menu.

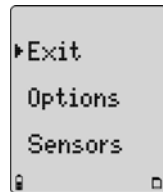
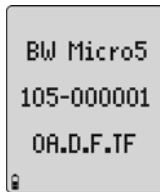

2. To scroll through the options, press ▼ or ▲. When the cursor displays beside the desired option, press ○.
3. To return to the previous menu, scroll to **Back** and press ○ or press Ⓞ.

*Note*

*If no pushbuttons are pressed within 20 seconds, the detector returns to normal operation.*

### **Exit User Options Menu**

To exit the user options menu and return to normal operation, scroll to **Exit** and press ○. The following screen displays.

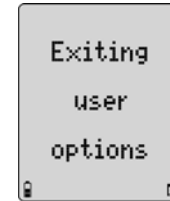

The user options menu can also be exited by repeatedly pressing Ⓞ until the detector returns to normal operation.

### **Options Menu**

Each feature within the **Options** menu is enabled/disabled by pressing ○ to toggle between the checkboxes.

Enabled	<input checked="" type="checkbox"/>
Disabled	<input type="checkbox"/>

### Backlight

The **Backlight** (backlight) option enables the LCD backlight to activate automatically in low-light conditions.

If disabled, the backlight activates only when the detector is in alarm mode.

*Note*

*In stealth mode, the backlight does not activate.*

The detector is shipped with the **Backlight** option enabled.

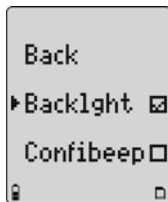

### Confidence Beep

The **Confibeep** (confidence beep) option provides continuous confirmation that the detector is operating properly. When confidence beep is enabled, the audible alarm beeps once every 10 seconds.

*Note*

*Confidence beep is automatically disabled during a low battery alarm.*

The detector is shipped with the **Confibeep** option disabled.

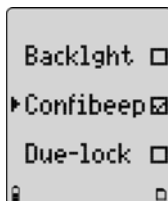

### Due-Lock

If the **Due-lock** (calibration user lockout) option is enabled and a sensor is overdue for calibration upon startup, the passcode must be entered to access normal operation.

*Note*

*If the correct passcode is not entered, the detector deactivates.*

The detector is shipped with the **Due-lock** option disabled.

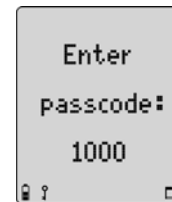
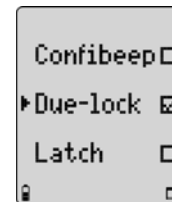

### Latched Alarms

If enabled, the **Latch** (latched alarms) option causes the low and high gas alarms (audible, visual, and vibrator) to persist until they are acknowledged. Press  $\bigcirc$  to acknowledge the alarm.

After the alarm is acknowledged, it reactivates every 30 seconds until the gas concentration is below the setpoint.

The detector is shipped with the **Latch** option disabled.

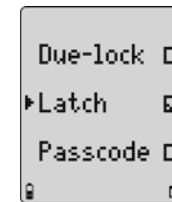

### Passcode Protect

The **Passcode** option prevents unauthorized access to the user options menu, the calibration function, and to adjusting the alarm setpoints.

#### Note

*The passcode is provided separately.*

If passcode protect is enabled and the **Enter passcode: 1000** screen displays, press ▲ or ▼ to scroll to the correct passcode and then press ○ to confirm.

The detector is shipped with the **Passcode** option disabled.

If an incorrect passcode is entered or ○ is not pressed within 5 seconds to confirm the correct passcode, **Passcode incorrect** displays. The alarm beeps three times and the detector either

- resumes normal operation (for user options), or
- deactivates (for calibration if **Due Lock** is enabled).

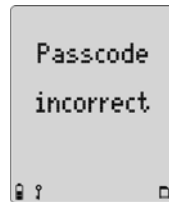
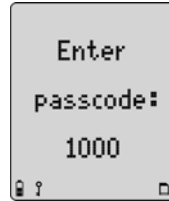
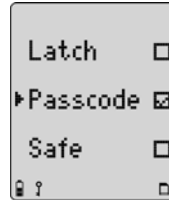

### Safe Display

When enabled, the **Safe** option confirms that conditions are normal and there are no gas hazards present. When all gas levels are normal or below the alarm setpoints, **Safe** displays continually on the LCD.

The detector is shipped with the **Safe** option disabled.

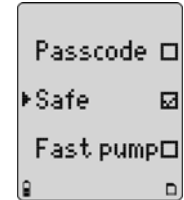

## **Sensor Configuration**



The **Sensor** option provides access to additional options and functions for each sensor.

Depending upon the sensor that is selected, some or all of the following options are available for configuration:

- Enabling/disabling a sensor
- Setting the span gas value
- Adjusting the STEL period (not applicable to LEL and O<sub>2</sub> sensors)
- Selecting the TWA method (not applicable to LEL and O<sub>2</sub> sensors)
- Resolution setting (not applicable to CO, LEL, O<sub>2</sub>, and CO<sub>2</sub> sensors)
- % vol CO<sub>2</sub> (CO<sub>2</sub> sensor only)
- % vol CH<sub>4</sub> (LEL sensor only)
- Selecting the correction factor (LEL and PID sensors only)
- Automatic calibration (O<sub>2</sub> sensor only)

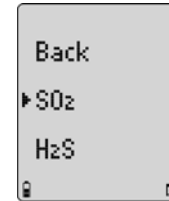
1. From the option menu screen, scroll to **Sensors** and press  to access the following screen.



2. Press  or  to scroll to the desired sensor. Press  to confirm and to access the menu options specific to the selected sensor.

For all sensor options, if a value is changed but not confirmed within 5 seconds, the detector emits an audible alarm and displays the following error message.

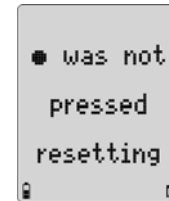

The detector retains the previous setting and returns to the user options menu.

*Sensor Enable/Disable*

**⚠ Warning**

**Disabling a sensor should only be performed with extreme caution. The disabled sensor cannot measure and alarm against the applicable gas.**

If a sensor fails, disabling the sensor deactivates the fail alarm. The sensor should be replaced and enabled as soon as possible. The detector will function normally with the remaining enabled sensors.

*Note*

*Detectors that are configured for a 1, 2, 3, or 4 gases may contain a dummy sensor in one of the four sensor locations.*

After selecting the desired sensor, the following screen displays.

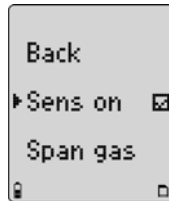

Press  to toggle between enable/disable (sensor can be enabled at any time).

- Enabled
- Disabled

If disabled, the readings and the gas type for the sensor do not display when in normal operation.

If a sensor is enabled but it is not installed in the detector, **FAIL** flashes above the gas type of the missing sensor.

**Disabled**

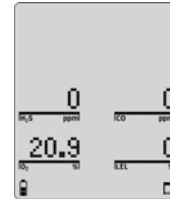

**Enabled/not installed**

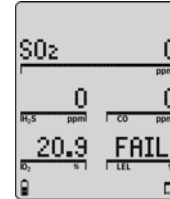

If all the sensors are disabled, the following screens display.

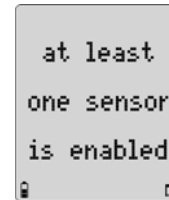
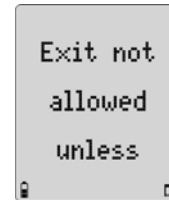

Enable one or more sensors to exit and access normal operation.

## Span Gas Value

The **Span gas** option increases or decreases the gas concentration for calibration (must match the gas concentration listed on the gas cylinder).

After selecting the sensor, press  $\blacktriangledown$  to scroll to **Span gas** and press  $\bigcirc$  within 20 seconds to confirm.

Depending upon the sensor selected, a screen similar to **A** or **B** displays. Press  $\blacktriangle$  or  $\blacktriangledown$  to scroll to the desired value and press  $\bigcirc$  within 5 seconds to confirm.

If  $\bigcirc$  is not pressed within 5 seconds to confirm the new value, the detector retains the previous value and returns to the user options menu.

### Note

*BW recommends that span concentration values be set between specific ranges.*

Refer to the [Resetting Gas Alarm Setpoints](#).

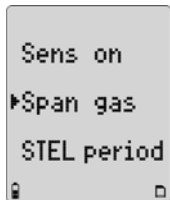

**A**

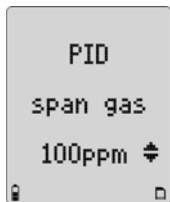

**B**



## STEL Period

The short-term exposure limit (**STEL period**) option provides protection for workers from over exposure to high concentrations of gas, and is based on 5-15 minute intervals.

The **STEL period** option is available for every toxic sensor.

After selecting the desired sensor, press  $\blacktriangledown$  to scroll to **STEL period** and press  $\bigcirc$  within 20 seconds to confirm.

The STEL period can be set from 5 to 15 minutes. Press  $\blacktriangle$  or  $\blacktriangledown$  to scroll to the required value, and then press  $\bigcirc$  within 5 seconds to confirm.

If  $\bigcirc$  is not pressed within 5 seconds to confirm the new value, the detector retains the previous value and returns to the user options menu.

The detector is shipped with the **STEL period** set to 15 minutes.

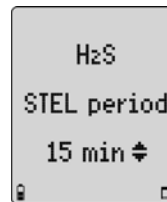
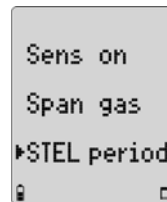

### TWA Method

The **TWA method** (time-weighted average) option is a safety measure used to calculate accumulated averages of gases to notify the user when the maximum average is accumulated. The options are the **OSHA** or **ACGIH** calculating method.

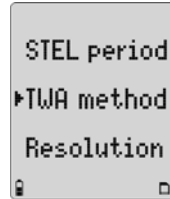

**OSHA Method:** 8 hour moving average – oldest value (first hour) is replaced by the newest value (ninth hour).

**ACGIH Method:** Infinite accumulated average to 8 hours – total accumulation, whether it is 2 hours or 8 hours.

After selecting the desired sensor, press  $\blacktriangledown$  to scroll to **TWA method**. Press  $\bigcirc$  within 20 seconds to confirm.

A check displays in the checkbox of the currently selected method. To select the other method, press  $\blacktriangledown$  to move the check to the other method. Press  $\bigcirc$  to confirm the selection.

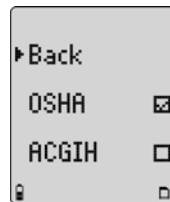

The detector is shipped with the **OSHA** method enabled.

#### Note

*If the TWA method has been changed, the TWA, STEL, and MAX values must be reset to ensure the TWA is calculated correctly. Refer to [Clearing Gas Exposures](#).*

### Resolution

The **Resolution** option displays the gas measurement using **Regular** or **Extra** resolution.

**Regular:** Displays gas measurement in 1 ppm increments.

**Extra:** Displays the gas measurement in 0.1 ppm increments.

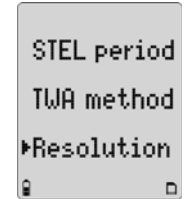

#### Note

**Regular resolution for O<sub>3</sub> and ClO<sub>2</sub> sensors is 0.1 ppm, while extra resolution is 0.01 ppm.**

**The Resolution option is not available for CO, O<sub>2</sub>, LEL, PID, and CO<sub>2</sub> sensors.**

After selecting the desired sensor, press  $\blacktriangledown$  to scroll to **Resolution**. Press  $\bigcirc$  within 20 seconds to confirm.

A check displays in the checkbox of the currently selected resolution. To select the other resolution, press  $\blacktriangledown$  to move the check to other resolution. Press  $\bigcirc$  to confirm the selection.

The detector is shipped with **Regular** resolution enabled for applicable sensors.

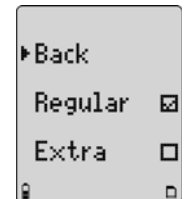

### %Vol CO<sub>2</sub> (CO<sub>2</sub> Sensors Only)

If the **%vol CO<sub>2</sub>** is enabled, the detector displays the carbon dioxide (CO<sub>2</sub>) readings as %vol (**0.0**).

From the **Sensors** option menu, select **CO<sub>2</sub>**.

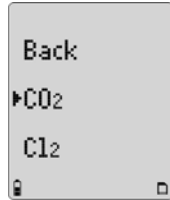

Press  $\blacktriangledown$  to scroll to **%vol CO<sub>2</sub>**. Press  $\bigcirc$  to toggle between enable and disable.

Confirmation is not required. If no buttons are pushed, after 20 seconds the detector returns to the sensor selection screen. The change is saved automatically.

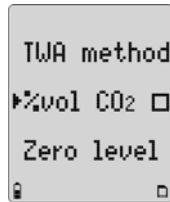

The detector is shipped with **%vol CO<sub>2</sub>** disabled.

Enable   
Disable

*Note*

*Correction factors are not applicable to the CO<sub>2</sub> sensor.*

### %Vol CH<sub>4</sub> (LEL Sensors Only)

If **%vol CH<sub>4</sub>** is enabled, any currently enabled correction factor is ignored and the detector operates assuming a methane (CH<sub>4</sub>) calibration.

From the **Sensors** menu, select **LEL** and press  $\bigcirc$  to confirm.

Next, press  $\blacktriangledown$  to scroll to **%vol CH<sub>4</sub>** and press  $\bigcirc$  within 20 seconds to confirm.

Press  $\bigcirc$  to toggle between enable and disable.

Confirmation is not required. If no buttons are pushed within 20 seconds, the detector returns to the sensor selection screen. The change is saved automatically.

The detector is shipped with **%vol CH<sub>4</sub>** disabled.

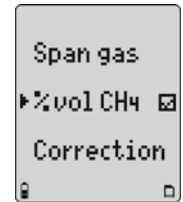
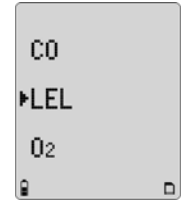

Enable   
Disable

### Correction Factor (CF)

Depending upon the selected sensor, refer to the following sections [LEL Sensor](#) or [PID Sensor](#) for more information.

*Note*

*Corrections factors are not applicable to CO<sub>2</sub> sensors.*



## LEL Sensor

This option is used to enter compensation factors for hydrocarbons other than methane. The factor can only be applied if the LEL sensor has been calibrated with methane.

After selecting the **LEL** sensor, press  $\blacktriangledown$  to scroll to **Correction**. Press  $\bigcirc$  within 20 seconds to confirm and access the LEL correction library.

Scroll to the required gas type and press  $\bigcirc$ . A check displays in the corresponding checkbox. The detector automatically applies the correction factor.

To disable the **Correction** option, press  $\blacktriangledown$  to scroll to **None** or to **Methane**. A check displays in the corresponding checkbox. If required, select a different gas type correction factor.

**Custom:** To enter a correction factor that is not listed in the library, press  $\blacktriangledown$  to scroll to **Custom** and press  $\bigcirc$  within 5 seconds to confirm.

The Custom LEL correction screen displays. Press  $\blacktriangle$  or  $\blacktriangledown$  to select the required value, and press  $\bigcirc$  within 5 seconds to confirm.

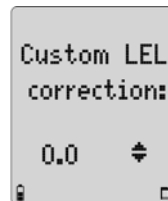
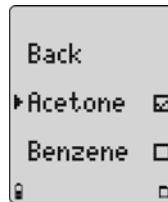
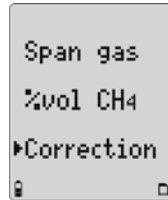

## PID Sensor

This option is used to enter compensation factors for selected gas types. The factor can only be applied if the PID sensor has been calibrated with isobutylene.

After selecting the **PID** sensor, press  $\blacktriangledown$  to scroll to **Correction**. Press  $\bigcirc$  within 20 seconds to confirm and access the PID correction library.

Scroll to the required gas type and press  $\bigcirc$ . A check displays in the corresponding checkbox. The detector automatically applies the correction factor.

To disable the **Correction** option, press  $\blacktriangledown$  to scroll to **None** or to **Isobutyl**. A check displays. If required, select a different gas type correction factor.

**Custom:** To enter a correction factor for a custom PID sensor, scroll to **Custom** and press  $\bigcirc$ . Press  $\blacktriangle$  or  $\blacktriangledown$  to scroll to the required value, and press  $\bigcirc$  within 5 seconds to confirm. Refer to the PID Correction Factor [PID Correction Factor \(CF\) Library](#) Library for gas types and corresponding correction factor values.

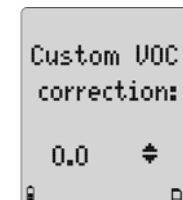
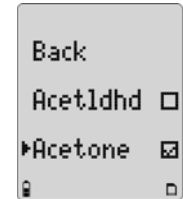
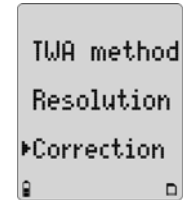

### Automatic Oxygen (O<sub>2</sub>) Calibration

When the **Autocal** option is enabled, it forces the detector to automatically calibrate the oxygen sensor during startup.

If the **Autocal** option is enabled, ensure the detector is activated in a safe area that is free of hazardous gas in an atmosphere of 20.9% oxygen.

From the **Sensor** menu, press  $\blacktriangledown$  to scroll to **O<sub>2</sub>** and press  $\bigcirc$  within 20 seconds to confirm.

Press  $\blacktriangledown$  to scroll to **Autocal**. Press  $\bigcirc$  to toggle between enable/disable.

The detector is shipped with the **Autocal** option enabled.

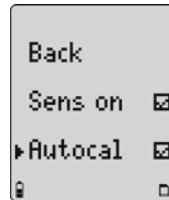
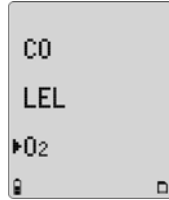

### Logger Option

The **Logger** option is used to define how often the detector records a datalog sample (once every 1 to 127 seconds).

From the user options menu, press  $\blacktriangledown$  to scroll to **Logger**. Press  $\bigcirc$  within 20 seconds to confirm.

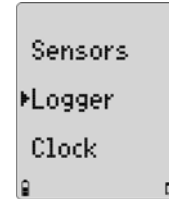

Press  $\blacktriangle$  or  $\blacktriangledown$  to change the current logger rate. When the desired value displays, press  $\bigcirc$  within 5 seconds to confirm the new value.

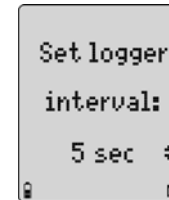

If  is not pressed within 5 seconds, the following screen displays.

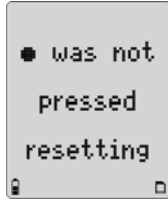

The detector is shipped with the datalog sample time set to **5 seconds**.

### ***Clock Option***

The **Clock** option is used to change the date and time.

From the user options menu, press  to scroll to **Clock**. Press  within 20 seconds to confirm.

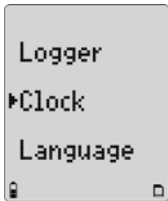

The screen displays showing the month highlighted indicating it is selected to set.

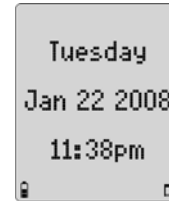

Press  or  to scroll to the desired month and press  within 20 seconds to confirm. To bypass and retain the current setting, press . Continue setting/bypassing the remaining options.

The date/time options are set in the following order:

- month
- day
- year
- hour
- minutes

When the settings have been set or bypassed, the detector beeps twice and returns to the user options menu.

*Note*

*The detector is shipped with the date and time set to Mountain Standard Time (MST).*

## Language Selection

The detector is shipped with **English** selected as the default language. The available languages are as follows:

- **Français** (French)
- **Deutsch** (German)
- **Español** (Spanish)
- **Prtuguês** (Portuguese)

Press  $\blacktriangledown$  to scroll to **Language** and press  $\bigcirc$  within 20 seconds to confirm.

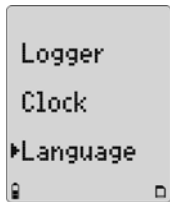

Press  $\blacktriangle$  or  $\blacktriangledown$  to scroll to the desired language and press  $\bigcirc$ . A check displays in the checkbox of the selected language.

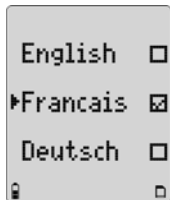

Wait for 20 seconds until the detector returns to the user options menu, or press  $\blacktriangle$  to scroll to **Back** (English), **Retour** (French), **Zurück** (German), **Regreso** (Spanish), or **Retornar** (Portuguese).

All screens now display in the selected language.

## Tech Mode



### $\triangle$ Warning

**Tech mode should only be accessed by authorized personnel.**

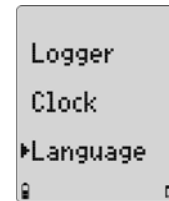
**Tech mode** can only be accessed from the **Language** option. Press  $\blacktriangledown$  to scroll to **Language**. Do not press  $\bigcirc$  until instructed.



In the following order, press and continue to hold each button until **Tech mode** displays below the **Language** option.

1. Press and hold  with the right index finger.
2. Press and hold  with the right middle finger.
3. Press and hold  with the left thumb.

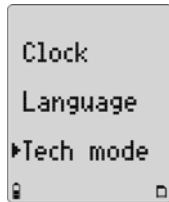

4. Press  to enter **Tech mode**. The options are as follows:

- [Sensors](#)
- [Initialize](#)
- [Force Calibration](#) (Force calibration)
- [Bump Daily](#) (Bump test daily)
- [Stealth Mode](#)
- [Sleep Mode](#)

## Sensors





### **Caution**

**To reconfigure the sensor type, physically change the sensor prior to entering Tech mode.**

When a toxic sensor is physically removed and replaced by another toxic sensor, the detector must be reconfigured to recognize the change.

### *Note*

*If a sensor is replaced, the detector will classify the sensor as overdue for calibration. Calibrate the new sensor immediately.*

1. Press  to scroll to **Sensors**. Press  within 20 seconds to confirm and access the toxic sensor menu.
2. Press  or  to scroll to **Toxic 1** or **Toxic 2** and press  within 20 seconds to confirm.

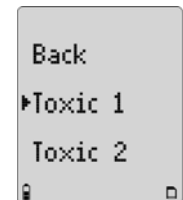
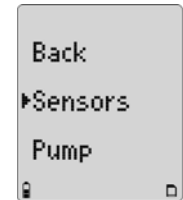

A corresponding list of toxic sensors displays. A checkbox displays beside the current toxic sensor.

*Note*

**Toxic 1:** List includes the PID and CO<sub>2</sub> sensors.

**Toxic 2:** List includes the H<sub>2</sub>S/CO COSH sensor.

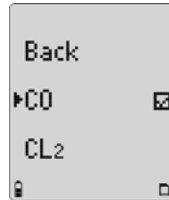

3. Press  $\blacktriangle$  or  $\blacktriangledown$  to scroll to the new sensor and press  $\bigcirc$  to confirm. A checkbox displays beside the new sensor. To reconfigure, exit the user options menu.

The following screen displays. The detector deactivates and immediately reactivates. It performs the reconfiguration during the startup.

The new sensor must be calibrated. Until the new sensor is calibrated, the due date displays as **OL** (over limit) when in normal operation.

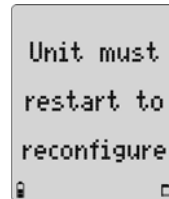

4. Calibrate the new sensor immediately.

### Initialize

The **Initialize** option restores the original factory default settings of the detector.

1. Press  $\blacktriangledown$  to scroll to **Initialize** and press  $\bigcirc$  within 20 seconds to confirm.
2. From the **Initialize?** screen perform one of the following options within 5 seconds.
  - Press  $\odot$  **No** to exit, or
  - Press  $\bigcirc$  **Yes** to initialize.

If **No** is selected, the following screen displays and the detector exits the initialize option.

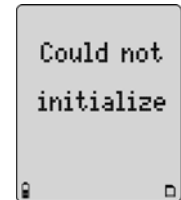
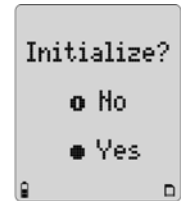
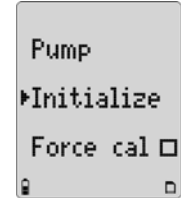

If **Yes** is selected, the following screen displays while performing the initializing process.

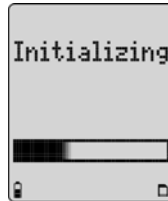

When initializing is complete, the following screen displays.

The detector deactivates and then immediately reactivates. The detector then reconfigures to the default settings while it performs the self-test.

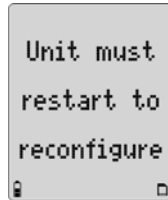

Verify all settings and alarm setpoints, and then calibrate the sensors.

### Force Calibration

If enabled, the **Force cal** option automatically forces the detector to enter calibration if a sensor is overdue upon startup. Press  $\blacktriangledown$  to scroll to **Force cal**.

Press  $\bigcirc$  to toggle between enable and disable.

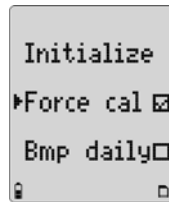

The detector is shipped with the **Force cal** option disabled.

### Bump Daily

If enabled, the **Bmp daily** option forces the detector to perform a daily bump test to ensure that it is responding to the test gas.

Press  $\blacktriangledown$  to scroll to **Bmp daily**. Press  $\bigcirc$  to toggle between enable/disable.

When enabled, the following screen displays during the startup self-test.

The bump test must be performed for the LEL and O<sub>2</sub> sensors, otherwise the detector will deactivate. Refer to [Bump Daily Enabled](#) for procedures.

The detector is shipped with the **Bmp daily** option disabled.

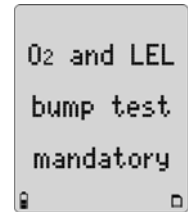
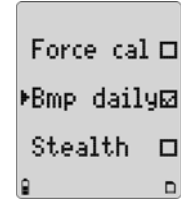



#### Note

*If **Bmp daily** is enabled, the O<sub>2</sub> and LEL sensors require daily bump tests whenever the detector is activated (or reactivated) following 00:00 hours (midnight).*

### Stealth Mode

The **Stealth** option disables the backlight, visual alarms, and audible alarms when concealment is required.

Only the vibrator and the LCD activate during an alarm condition.

Press  to scroll to **Stealth**. Press  to toggle between enable and disable.

The detector is shipped with the **Stealth** option disabled.

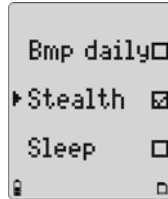



### Sleep Mode

#### Note

*BW recommends the **Sleep** option be enabled when using rechargeable battery packs.*

If **Sleep** is enabled, sensor circuits remain active after the detector is deactivated and inserted into the charging cradle.

Press  to scroll to **Sleep**. Press  to toggle between enable/disable.

#### Note

*Enabling the **Sleep** option may require the battery be charged more frequently.*

The detector is shipped with the **Sleep** option disabled.





## Alarms

The following table describes the detector alarms and corresponding screens.

- During an alarm condition, the detector activates the backlight and displays the current ambient gas reading.
- If more than one type or level of alarm exists simultaneously, a multi alarm results.
- To change the factory-set alarm setpoints, refer to [Calibration and Setting Alarm Setpoints](#).

**Table 7. Alarms**

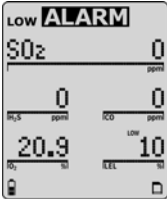
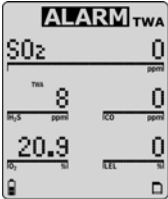
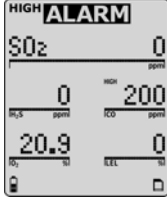
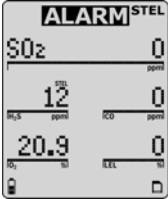
Alarms	Screen`	Alarms	Screen
<p><b>Low Alarm</b></p> <ul style="list-style-type: none"> <li>• Fast beep</li> <li>• Slow flash</li> <li>• <b>ALARM</b> and gas type flash</li> <li>• Vibrator alarm activates</li> </ul>		<p><b>TWA Alarm</b></p> <ul style="list-style-type: none"> <li>• Fast beep</li> <li>• Slow flash</li> <li>• <b>ALARM</b> and gas type flash</li> <li>• Vibrator alarm activates</li> </ul>	
<p><b>High Alarm</b></p> <ul style="list-style-type: none"> <li>• Constant beep</li> <li>• Fast flash</li> <li>• <b>ALARM</b> and gas type flash</li> <li>• Vibrator alarm activates</li> </ul>		<p><b>STEL Alarm</b></p> <ul style="list-style-type: none"> <li>• Constant beep</li> <li>• Fast flash</li> <li>• <b>ALARM</b> and gas type flash</li> <li>• Vibrator alarm activates</li> </ul>	

**Table 7. Alarms**







Alarms	Screen	Alarms	Screen
<p><b>Multi Alarm</b></p> <ul style="list-style-type: none"> <li>Alternating low and high alarm beep and flash</li> <li><b>ALARM</b> and gas types flash</li> <li>Vibrator alarm activates</li> </ul>		<p><b>Over Limit (OL) Exposure Alarm</b></p> <ul style="list-style-type: none"> <li>Fast beep and flash</li> <li><b>ALARM</b> and gas type flash</li> <li>Vibrator alarm activates</li> </ul>	
<p><b>Sensor Alarm</b></p> <ul style="list-style-type: none"> <li>One beep every 15 seconds</li> <li><b>FAIL</b> flashes above the failed sensor</li> </ul>		<p><b>Automatic Deactivation Alarm</b></p> <ul style="list-style-type: none"> <li>Eight beeps and flashes</li> <li><sup>LOW</sup>  displays</li> <li>Vibrator alarm temporarily activates</li> </ul>	
<p><b>Low Battery Alarm</b></p> <ul style="list-style-type: none"> <li>One beep and two flashes every 25 seconds</li> <li><sup>LOW</sup>  flashes</li> </ul>		<p><b>Normal Deactivation</b></p> <ul style="list-style-type: none"> <li>Three beeps and flashes</li> </ul>	

Table 7. Alarms

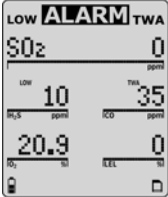
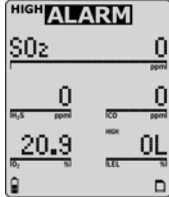
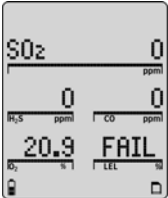
Alarms	Screen	Alarms	Screen
<p><b>Confidence Beep</b></p> <ul style="list-style-type: none"> <li>One beep, one flash, and one vibrate every 10 seconds</li> </ul>		<p><b>MMC/SD Fail Alarm</b></p> <ul style="list-style-type: none"> <li>One beep every 5 seconds</li> <li>□ flashes</li> </ul>	
Alarms		Screen	
<p><b>Pump Alarm</b></p> <ul style="list-style-type: none"> <li>Two fast beeps and alternating flashes</li> <li>Vibrator alarm activates</li> <li><b>ALARM</b> and 🌀 flash</li> </ul>			

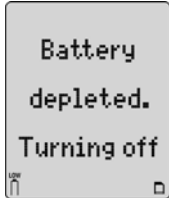
*Note*

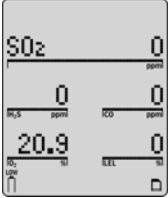
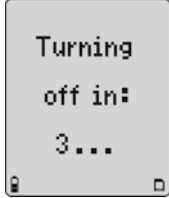
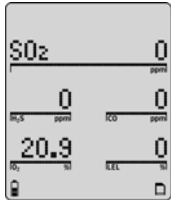
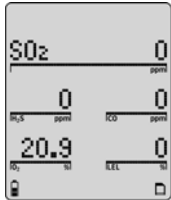
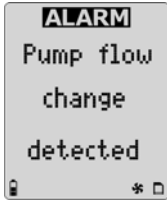
If the **Latch** (latched alarms) option is activated, the audible, visual, and vibrator alarms persist until the alarm condition is acknowledged. To acknowledge a latched alarm, press ○. The alarms cannot be deactivated if an alarm condition exists.

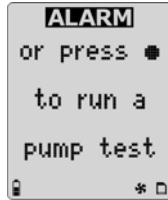
If the **Stealth** option is enabled, the detector only vibrates during an alarm; the audible and visual alarms are disabled.

**⚠ Caution:** If the detector emits a low battery alarm, charge the lithium battery pack immediately.

**Gas Exposures Computed**

**⚠ Warning**

To avoid possible personal injury, do not deactivate the detector during a work shift. TWA and STEL readings reset if the detector is deactivated for more than 5 minutes.

**Table 8. Computed Gas Exposures**

Gas Exposure	Description
TWA (toxic only)	Time-weighted average (TWA) based on accumulated exposure to toxic gases averaged over a work day according to OSHA or ACGIH method.
STEL (toxic only)	Short-term exposure limit (STEL) to gas based on a 5-15 minute user selectable period.
*Peak (MAX)	Peak (MAX) concentration exposure during work shift.

\*For oxygen, it is the highest or the lowest concentration encountered.

**Viewing Gas Exposures**

Press and hold  until the peak (MAX) gas exposures displays.



The TWA gas exposures display next.

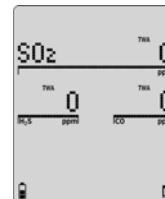

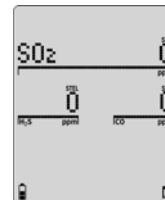

The STEL gas exposures display last.





### Clearing Gas Exposures

The exposures automatically clear after 5 minutes when the detector is deactivated.

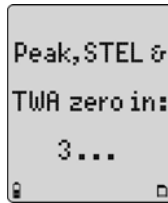
To clear the MAX, TWA, and STEL exposure readings immediately, press and hold  and  simultaneously. The detector displays the following screen during the countdown.



*Note*

*Hold  and  for the entire countdown, otherwise the MAX, TWA, and STEL exposure readings will not clear.*

### Gas Alarm Setpoints

The gas alarm setpoints trigger the gas alarms and are described in [Table 9](#).

**Table 9. Gas Alarm Setpoints**

Alarm	Condition
Low alarm	<i>Toxics and combustibles:</i> Ambient gas level above low alarm setpoint. <i>Oxygen:</i> Ambient gas level may be set above or below 20.9%.
High alarm	<i>Toxics and combustibles:</i> Ambient gas level above high alarm setpoint. <i>Oxygen:</i> Ambient gas level may be set above or below 20.9%.
TWA alarm	<i>Toxic only:</i> Accumulated value above the TWA alarm setpoint.
STEL alarm	<i>Toxic only:</i> Accumulated value above the STEL alarm setpoint.
Downscale alarm	<i>Toxic:</i> If sensor reading is negative (half of the TWA setpoint). <i>LEL:</i> If sensor reading is negative (half of the low alarm setpoint).
Multi alarm	Two or more gas alarm conditions.

### Viewing the Alarm Setpoints

To view the current alarm setpoints for all of the sensors, press  during normal operation.

The time/date, TWA, STEL, low, and high alarm setpoint screens display in the following order left to right:

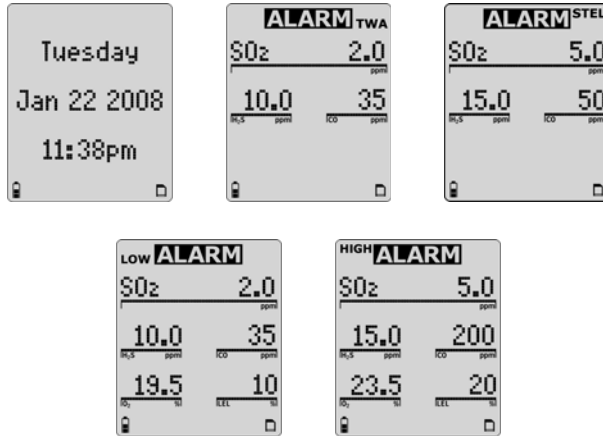

If a correction factor has been applied to a sensor, one of the following screens display indicating the sensor and gas type.

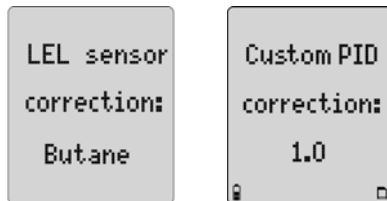

## Resetting Gas Alarm Setpoints

*Note*

*Standard factory alarm setpoints may vary by region.*

The following table lists the factory alarm setpoints according to the Occupational Safety and Health Association (OSHA) settings.

**Table 10. OSHA Sample Factory Alarm Setpoints**

Gas	TWA	STEL	Low	High
O <sub>2</sub>	N/A	N/A	19.5% vol.	23.5% vol.
LEL	N/A	N/A	10% LEL	20% LEL
CO	35 ppm	50 ppm	35 ppm	200 ppm
H <sub>2</sub> S	10 ppm	15 ppm	10 ppm	15 ppm
PH <sub>3</sub>	0.3 ppm	1.0 ppm	0.3 ppm	1.0 ppm
SO <sub>2</sub>	2 ppm	5 ppm	2 ppm	5 ppm
Cl <sub>2</sub>	0.5 ppm	1.0 ppm	0.5 ppm	1.0 ppm
NH <sub>3</sub>	25 ppm	35 ppm	25 ppm	50 ppm
NO <sub>2</sub>	2.0 ppm	5.0 ppm	2.0 ppm	5.0 ppm
HCN	4.7 ppm	10.0 ppm	4.7 ppm	10.0 ppm
ClO <sub>2</sub>	0.1 ppm	0.3 ppm	0.1 ppm	0.3 ppm
O <sub>3</sub>	0.1 ppm	0.1 ppm	0.1 ppm	0.1 ppm
VOC	50 ppm	100 ppm	50 ppm	100 ppm
CO <sub>2</sub>	5,000 ppm	30,000 ppm	5,000 ppm	30,000 ppm

To change the factory-set alarm setpoints, refer to [Calibration and Setting Alarm Setpoints](#).

*Note*

To disable an alarm, set the alarm setpoint to **0** (zero).

### Stopping a Gas Alarm

The low and high alarms stop when the ambient gas level returns to below the low alarm setpoint.

*Note*

If alarms are set to latch, press  to reset the alarms.

#### **⚠ Caution**

**Follow all safety procedures as defined by your employer. Confirm with your supervisor before clearing TWA and STEL alarms.**

The TWA and STEL alarms can be stopped either by

- clearing the MAX, TWA, and STEL exposures (refer to [Clearing Gas Exposures](#)), or
- deactivating the detector for 5 minutes (minimum) and then reactivating it again.

### Sensor Alarm

The detector tests for missing or defective sensors during the activation self-test. If a sensor fails the self-test, **FAIL** flashes on the LCD above the failed sensor. Refer to [Troubleshooting](#).

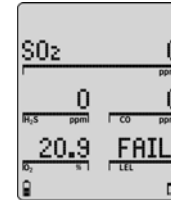

### Pump Alarm

The external pump draws air over the sensors continually. If the pump stops operating or becomes blocked, the detector activates the pump alarm. The following screens display.

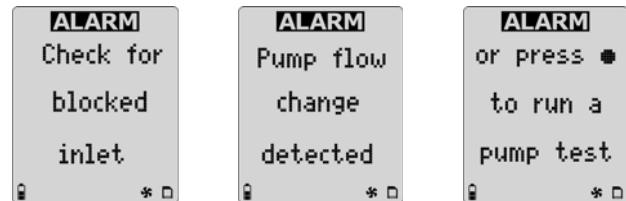

The pump alarm continues until the blockage is cleared or it is acknowledged by pressing . If  is pressed, the detector automatically launches a pump test to reset the pump module.

Refer to [Pump Test](#) for more information. If the pump test is successful, the detector returns to normal operation, otherwise the pump alarm continues. If the pump alarm persists, refer to the Pump Operation section in [Troubleshooting](#).

### **Low Battery Alarm**

The detector tests the batteries upon activation and continuously thereafter. Battery power is continually displayed during normal operation. If the battery voltage is low, the detector activates the low battery alarm.

The low battery alarm continues until the batteries are replaced/charged, or until the battery power is almost depleted. If the battery voltage becomes too low, the detector deactivates.

#### *Note*

*Typically, the low battery alarm continues for 30 minutes before the detector automatically deactivates.*

### **Automatic Deactivation Alarm**

If the battery voltage is in immediate danger of falling below the minimum operating voltage, the audible alarm beeps eight times and the visual alarm flashes eight times. After 3 seconds, the LCD dims and the detector deactivates.

To replace or charge the batteries, refer to the following sections:

- [Replacing the Alkaline Batteries](#)
- [Replacing the Lithium Battery Pack](#)

## **Calibration and Setting Alarm Setpoints**

### **Guidelines**

When calibrating the detector, adhere to the following guidelines:

Recommended gas mixture:

CO: 50 to 500 ppm balance N<sub>2</sub>

H<sub>2</sub>S: 10 to 100 ppm balance N<sub>2</sub>

PH<sub>3</sub>: 1 to 5 ppm balance N<sub>2</sub>

SO<sub>2</sub>: 10 to 50 ppm balance N<sub>2</sub>

Cl<sub>2</sub>: 3 to 25 ppm balance N<sub>2</sub>

NH<sub>3</sub>: 20 to 100 ppm balance N<sub>2</sub>

NO<sub>2</sub>: 5 to 50 ppm balance N<sub>2</sub>

HCN: 5 to 20 ppm balance N<sub>2</sub>

ClO<sub>2</sub>: 0.1 to 1.0 ppm balance N<sub>2</sub>

O<sub>3</sub>: 0.1 to 1.0 ppm balance N<sub>2</sub>

VOC: 100 ppm isobutylene

LEL: 50% LEL or 2.5% by vol. methane balance air

CO<sub>2</sub>: 5000 ppm balance air

O<sub>2</sub>: 18.0%

- To ensure accurate calibration, use a premium-grade calibration gas. Gases approved by the National Institute of Standards and Technology (NIST) improves the validity of the calibration.
- Do not use a gas cylinder beyond its expiration date.



- Calibrate a new sensor before use. Install the sensor, activate the detector, and allow the sensor to stabilize before starting calibration.  
Used sensor: 60 seconds / New sensor: 5 minutes
- Calibrate the detector at least once every 180 days (every 90 days for HCN sensors) depending upon use and sensor exposure to poisons and contaminants. For a list of common products that can damage sensors, refer to [Sensor Poisons and Contaminants](#).
- Calibrate the detector if the ambient gas varies during startup.
- Calibrate the sensor before changing the alarm setpoints.
- Calibrate only in a safe area that is free of hazardous gas in an atmosphere of 20.9% oxygen.
- To disable an alarm, set the alarm setpoint to **0** (zero).
- If the **Auto cal** option is enabled, the oxygen (O<sub>2</sub>) sensor calibrates automatically every time the detector is activated. Activate the detector in a safe area that is free of hazardous gas in an atmosphere of 20.9% oxygen.
- After activating the detector, allow it to stabilize for 1 minute before performing a calibration or bump test.
- If a certified calibration is required, contact [BW Technologies by Honeywell](#).

*Note*

*A generator must be used for O<sub>3</sub> and ClO<sub>2</sub> sensors.*

### ***Diagnostics Testing***

The detector tests the ambient air (auto zero) and the test gas that is applied (auto span) to ensure it meets expected values. Auto zero sets the zero-gas level of the sensor. If ambient gas is present, the zero level will be incorrect.

If excessive target gas is present, the detector displays an error message and lists the affected sensor.

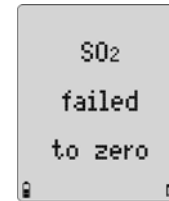

In auto span, if the target gas is not detected or does not meet expected values, a message displays that the detector is exiting calibration mode. The detector retains the previous set values.

## Applying Gas to the Sensors

The calibration cap, single gas calibration cap, and hose are shipped with the detector. Refer to [Figure 3](#), and [Table 11](#), for installation.

### Note

*The calibration cap and single gas calibration cap must only be used during the calibration span process.*

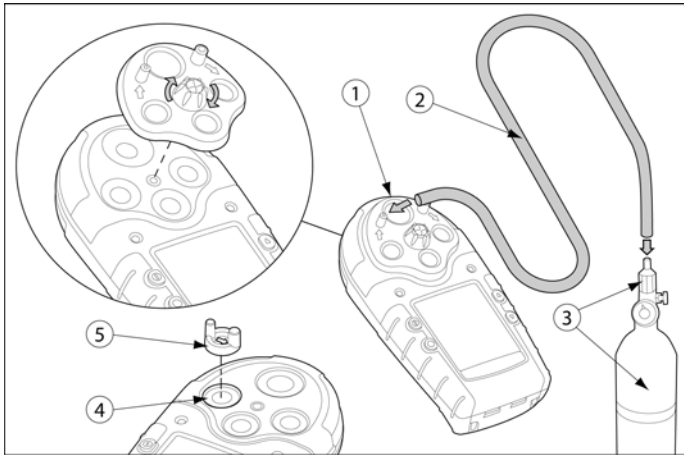

**Figure 3. Applying Gas to the Sensors**

**Table 11. Applying Gas to the Sensors**

Item	Description
1	Detector with calibration cap
2	Calibration hose
3	Regulator and gas cylinder
4	Toxic 2 sensor position
5	Single gas calibration cap

### Single Gas Calibration Cap

#### ⚠ Caution

**If an O<sub>3</sub> or ClO<sub>2</sub> sensor is located in the Toxic 2 position (refer to [Figure 3](#), and [Table 11](#)), a single gas calibration cap must be used to ensure accurate calibration.**

To calibrate O<sub>3</sub> and ClO<sub>2</sub> sensors using the single gas calibration cap, refer to [Figure 4](#), [Table 12](#), and complete the following procedures.

1. Insert the cap into the Toxic 2 sensor position on the detector (refer to [Figure 3](#)). Press firmly until the release tabs click.
2. Connect the calibration hose to the gas cylinder and to the intake inlet on the cap.
3. Proceed to [Calibration Procedure](#).

**Table 12. Single Gas Calibration Cap**

Item	Description
1	Intake inlet
2	Calibration hose
3	Gas flow direction arrow
4	Output outlet

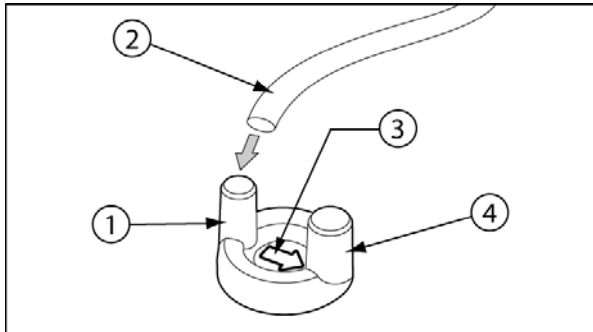

**Figure 4. Single Gas Calibration Cap**

*Note*

*The arrow on the cap indicates the direction of gas flow from intake to outtake.*

### Removing the Single Gas Calibration Cap

Using the thumb, push forward against both the inlet and the outlet simultaneously to remove the cap from the detector.

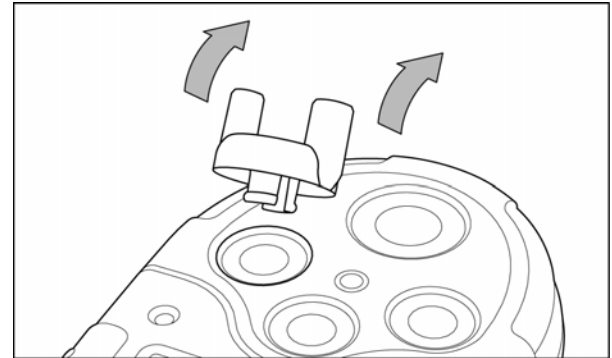

**Figure 5. Removing the Single Gas Calibration Cap**

### Calibration Procedure

To calibrate the detector and set the alarm setpoints, perform the following procedure.

*Note*

*To bypass a step during the calibration process (after auto zero), press Ⓞ.*



## Start Calibration

### Note

Verify that the calibration gas being used matches the span concentration value(s) that are set for the detector. Refer to [Span Gas Value](#). Correction factors are not applied during calibration. Correction factors that were set prior to calibration are restored when the detector returns to normal operation.

### ⚠ Caution

**Calibrate only in a safe area that is free of hazardous gas in an atmosphere of 20.9% oxygen.**

1. To enter calibration, press and hold  and  simultaneously as the detector beeps, flashes, and vibrates to the corresponding countdown.

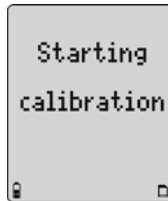

## Auto Zero and Oxygen (O<sub>2</sub>) Sensor Calibration

2. **AUTO-ZERO** flashes while the detector automatically zeroes the toxic and combustible sensors, and calibrates the O<sub>2</sub> sensor.

Depending upon the detector being calibrated, the auto zero screens display differently.

GasAlertMicro 5/PID

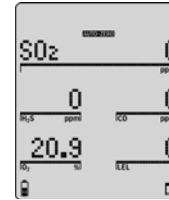

GasAlertMicro 5 IR

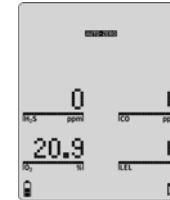

### Note

Do not apply calibration gas during this process, otherwise the auto zero step will fail.

## Zero CO<sub>2</sub> (GasAlertMicro 5 IR only)

If calibrating using the GasAlertMicro 5 or the GasAlertMicro PID, proceed to [Auto Span](#) step #5. If the detector is passcode protected, proceed to [Passcode Protect](#) step #4.

3. For GasAlertMicro 5 IR models, there is a second auto zero that is performed for the CO<sub>2</sub> sensor.

When auto zero for the other sensors is complete, the following screen displays.

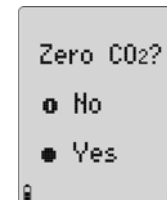

Press  **Yes** to zero the CO<sub>2</sub> sensor.

Or

Press  **No** to bypass the CO<sub>2</sub> zero and proceed to [Auto Span](#) step #5. If the detector is passcode protected, refer to [Passcode Protect Activated](#) step #4.

If  **Yes** is pressed, the following screen displays.

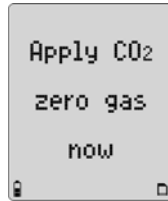

**⚠ Warning**

**Use nitrogen (N<sub>2</sub>) to zero the CO<sub>2</sub> sensor.**

Apply N<sub>2</sub> to zero the CO<sub>2</sub> sensor. The following screen displays.

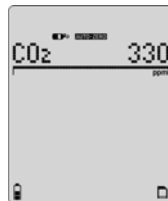

**AUTO-ZERO** flashes while the detector zeros the CO<sub>2</sub> sensor (approximately 30 seconds).

**Passcode Protect Activated**

4. When auto zero is complete and if the passcode protect option is enabled, the following screen displays.

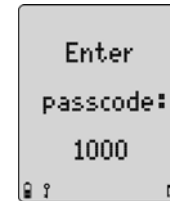

The passcode must be entered to proceed.

Press  or  to scroll to the correct passcode and then press  within 5 seconds to confirm. If entered correctly, the detector beeps twice and proceeds to [Auto Span](#) step #5.

**Incorrect Passcode:** If the passcode is incorrect or is not confirmed within 5 seconds by pressing , the following screens display.

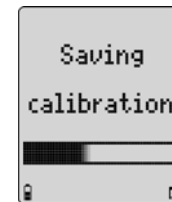
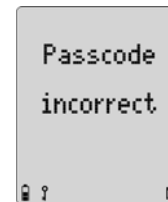

The detector saves the calibration and returns to normal operation.

### Auto Span

5. When auto zero is complete, the following screens display.

#### GasAlertMicro 5 and PID

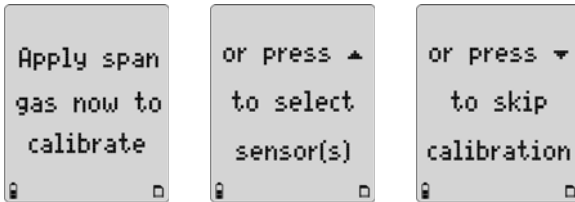

#### GasAlertMicro 5 IR

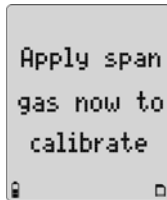

.Note

Span sensors in the following order:

- Exotics ( $NH_3$ ,  $ClO_2$ ,  $O_3$ ,  $Cl_2$ , and  $CO_2$ )
- Single gas
- Quad gas ( $H_2S$ ,  $CO$ ,  $LEL$ , and  $O_2$ )
- PID

### Note

*A generator must be used for  $O_3$  and  $ClO_2$  sensors.*

*To ensure accurate calibration, a single gas calibration cap must be used to calibrate  $O_3$  and  $ClO_2$  sensors.*

- **$ClO_2$ :** Use a Tedlar bag as a buffer between the generator and the detector (using the single gas calibration cap) to regulate the flow rate to ensure accurate readings.
- Allow the Tedlar bag to fill for several minutes before initiating calibration.
- **$O_3$ :** Calibrate using the generator and the single gas calibration cap. Do not use a Tedlar bag.
- Set the generator to 0.5 ppm at a flow rate of 0.5 l/min.

Depending upon the gas cylinder being used, one or all four sensors can be calibrated at one time.

### Apply Span Gas Now

Attach the calibration cap (or single gas calibration cap for  $O_3$  and  $ClO_2$ ) and apply gas to the sensor(s). To attach caps, refer to [Figure 3](#).

Refer to the following flow rates:

- 1000 ml/min. for  $NH_3$  and  $Cl_2$
- 500 ml/min. for  $CO_2$
- 250-500 ml/min. (all other sensors)

🔊 flashes as the detector initially detects the calibration gas.

**GasAlertMicro 5 and PID**

**GasAlertMicro 5 IR**

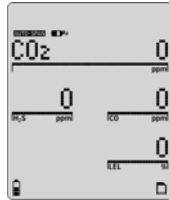

After 30 seconds the detector beeps and 🔊 stops flashing.

**AUTO-SPAN** flashes while spanning the sensors until the detector has attained a sufficient level of the expected gas.

Refer to [Table 13](#), for times required to span.

**Table 13. Time Required to Span**

Gas Type	Time Required to Span
Most toxic gases and CO <sub>2</sub>	2 minutes
Exotic toxic gases	5 minutes
LEL (combustibles)	30 seconds
PID gases	2 minutes

**Insufficient Level:** If a sensor does not attain a sufficient level of expected gas, it is cleared from the LCD and is not spanned.

While the detector is spanning the sensor(s), a countdown of time remaining displays in the lower left of the screen.

**GasAlertMicro 5 and PID**

**GasAlertMicro 5 IR**

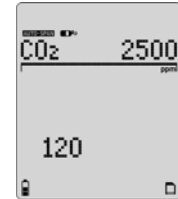
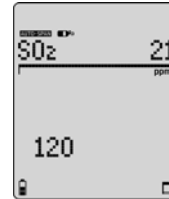

When the span is complete, the following screen displays.

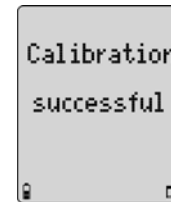

**Successful Span:** Proceed to [Successful Span](#) step #6.

**Unsuccessful Span:** Refer to **Unsuccessful Span** for possible solutions.

### Successful Span

6. If the sensor(s) has spanned successfully, the audible alarm beeps three times and the following screens display.



If there are more sensors to span, remove the current cylinder and connect the next gas cylinder.

Press ▲ and apply gas to span the other sensor(s).

Or

Press ▼ to end the span and proceed to [Setting the Calibration Due Date](#) step #7.

When all sensors have spanned, the following screen displays.



If a sensor fails to span, refer to **Unsuccessful Span** at the end of the calibration section for possible solutions.

### Setting the Calibration Due Date

7. When the span is complete, the calibration due date can be set for each sensor that has spanned successfully. The following screen displays.

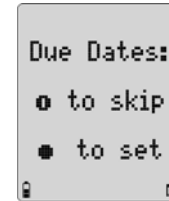

Press ○ to set the calibration due dates.

Or

Press ● to bypass and proceed to [Alarm Setpoints](#) step #8.

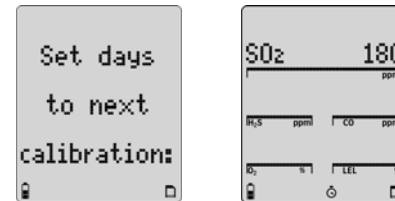

#### Note

*If a new due date is not entered, the detector automatically resets to the previously entered number of days.*



The calibration due dates are set in the following order:

- Toxic 1
- Toxic 2
- LEL
- O<sub>2</sub>

If the due date of an unsuccessfully spanned sensor is changed, the following screens display.

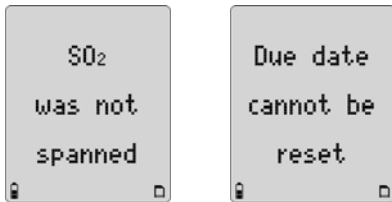

The detector then automatically proceeds to the next sensor.

To change the calibration due date (1-365 days), press  $\blacktriangledown$  or  $\blacktriangle$  until the new value displays. Press  $\bigcirc$  within 5 seconds to confirm.

Or

Press  $\textcircled{c}$  to bypass a sensor and proceed to the next sensor.

*Note*

*If a value is changed but  $\bigcirc$  is not pressed within 5 seconds to confirm, the following screen displays.*

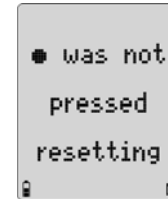

The previous value is automatically retained. The detector proceeds to the next sensor due date.

Repeat step #7 to set the calibration due dates for the remaining sensors.

When all of the due dates are entered, press  $\bigcirc$  to proceed to [Alarm Setpoints](#) step #8.

Or

Press  $\textcircled{c}$  to bypass setting the alarm setpoints and proceed to [Finish Calibration](#) step #10.

### Alarm Setpoints

- When all of the sensor due dates have been set or bypassed, the alarm setpoints need to be set or bypassed. The following screen displays.

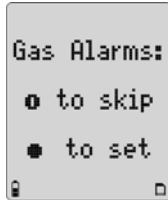

Factory alarm setpoints may vary by region. Refer to [Resetting Gas Alarm Setpoints](#) for an example.

Alarms can be set to any value within the detection range of the selected sensor. Refer to "Detection Range" in [Specifications](#).

*Note*

*To disable an alarm setpoint, set it to 0 (zero).*

If a new setpoint is entered but not confirmed within 5 seconds by pressing , the following screen displays.

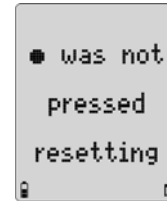

The previous setpoint is retained and the detector proceeds to the next setpoint.

The setpoints are set in the following order:

- TWA (if applicable)
- STEL (if applicable)
- low
- high

To bypass a setpoint, press  to save the current value and proceed to the next setpoint.

### Setting the TWA Alarm Setpoint

The current TWA alarm setpoint displays for the selected sensor (if applicable).

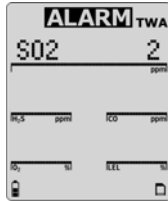

Press  $\blacktriangledown$  or  $\blacktriangle$  to change the value for the TWA alarm setpoint. When the required value displays, press  $\bigcirc$  to confirm.

### Setting the STEL Alarm Setpoint

The current STEL alarm setpoint displays for the selected sensor (if applicable).

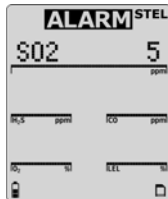

Press  $\blacktriangledown$  or  $\blacktriangle$  to change the value for the STEL alarm setpoint. When the required value displays, press  $\bigcirc$  to confirm.

### Setting the Low Alarm Setpoint

The current low alarm setpoint displays for the selected sensor.

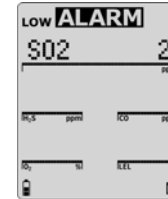

Press  $\blacktriangledown$  or  $\blacktriangle$  to change the value for the low alarm setpoint. When the required value displays, press  $\bigcirc$  to confirm.

### Setting the High Alarm Setpoint

The current high alarm setpoint displays for the selected sensor.

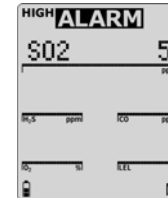

Press  $\blacktriangledown$  or  $\blacktriangle$  to change the value for the high alarm setpoint. When the required value displays, press  $\bigcirc$  to confirm.

Proceed to step #9 [Setting the Remaining Alarm Setpoints](#).

### *Setting the Remaining Alarm Setpoints*

9. Repeat step #8 to set the alarm setpoints for the remaining sensors. When complete, the detector emits two quick beeps and proceeds to [Finish Calibration](#).

### *Finish Calibration*

10. The detector displays the following screen to indicate that calibration is complete.

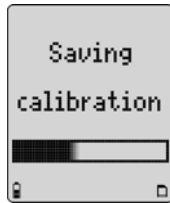

### *Verification*

1. After calibration is complete and the detector returns to normal operation, verify the calibration by using a gas cylinder other than the one used for calibration.
2. The gas concentration should not exceed the sensor's detection range. Confirm that the LCD displays the expected concentration values.
3. To ensure the reading is accurate, apply the verification gas for the same amount of time as was applied to the sensor when it was calibrated.

**Example:** SO<sub>2</sub> span time 2 minutes therefore, apply verification gas for 2 minutes.

### Unsuccessful Span

If the sensor(s) did not span successfully, refer to the following sections for possible solutions:

- [Failed Span](#)
- [No Gas Detected](#)
- [Did Not Reach Target Span](#)
- [Large Span](#)

### Failed Span

If a sensor fails the span, the following error message displays.

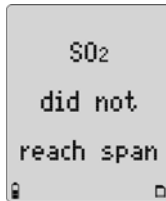

If the sensor is not calibrated, it displays as **FAIL** in normal operation the next time the detector is activated.

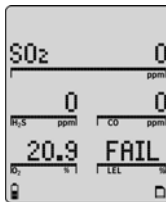

If all sensors fail the span, the following screen displays.

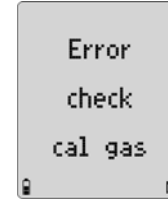

1. Ensure the regulator valve is open and that the gas cylinder is not past the expiration date. Replace the gas cylinder and/or regulator if required.
2. Replace the sensor(s) and sensor filter if required.
3. Press  $\odot$  to exit and then calibrate again in a safe area that is free of hazardous gas in an atmosphere of 20.9% oxygen.
4. If the span fails a second time, reactivate the detector to test the sensors.

If all sensors fail the span, the calibration due dates cannot be reset. The following screens display.

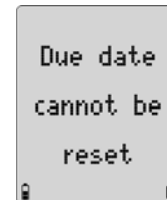

### No Gas Detected

If the detector does not detect any gas within 30 seconds, the following screens display.

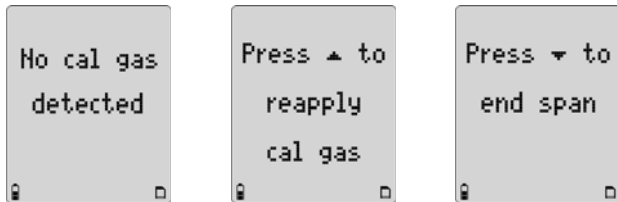

1. Ensure the regulator valve is open and the calibration hose is free of debris.
2. Replace the gas cylinder and/or regulator if required.
3. Replace the sensor(s) and sensor filter if required.
4. Press ▲ to reapply gas or press ▼ to end the span.

### Did Not Reach Target Span

If the target span was not achieved, as defined in the [Span Gas Value](#) option, the following screens display.

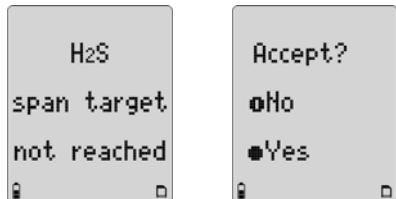

Not reaching the target span can result from

- a problem with the span gas,
- the gas cylinder being past the expiry date, or
- a problem with the sensor.

**Accept Current Span:** If the gas cylinder, regulator, and sensor are operating correctly, press ○ to accept the current span.

**Reject Current Span:** Press ⊕ to reject. Verify the gas cylinder, detector settings, and sensor are operating correctly. Calibrate the sensor again.

### Large Span

If the span adjustment is unusually large (more than 15%), the following screens display.

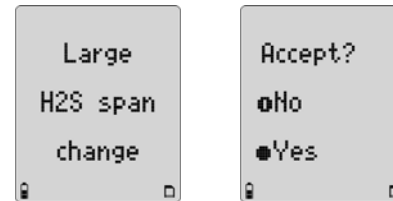

Ensure the correct gas cylinder being used and that the span concentration value(s) of the detector matches the span concentration value(s) of the gas cylinder. Refer to [Span Gas Value](#).

**Adjustment Expected:** If the calibration adjustment is expected, press ○ to accept the span.

**Adjustment Not Expected:** If the calibration adjustment is not expected or the span gas value does not match the gas cylinder, press ⊕ to reject the span and calibrate that sensor again.

## Attaching the Accessories

### Installing the Pump Module

The pump module can be used independently to measure gas or it can be used with the sample probe to test for gases in confined spaces. To measure gas using the sample probe, refer to [Attaching the Sample Probe](#).

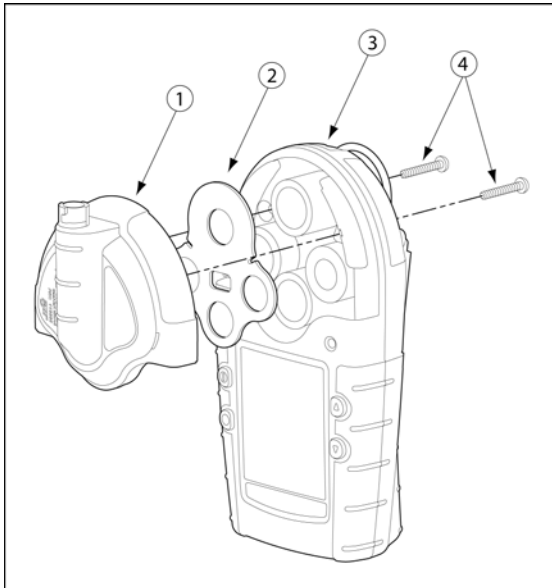

**Figure 6. Installing the Pump Module**

**Table 14. Installing the Pump Module**

Item	Description
1	Pump module
2	Sensor filter
3	Detector
4	Machine screws (2)

To install the pump module, refer to [Figure 6](#), [Table 14](#)., and the following procedures.

1. Deactivate the detector.
2. Remove the two machine screws and the sensor cover. Remove the sensor filter from the sensor cover and insert it into the pump module.
3. Attach the pump module to the detector and replace the two machine screws.
4. If sampling in a confined space, attach the sample probe. Refer to [Attaching the Sample Probe](#).  
If using an auxiliary filter as an additional filtration system, refer to [Attaching the Auxiliary Filter](#).
5. Activate the detector. The detector performs a pump test during the startup self-tests. Refer to [Pump Test](#).

## Replacing the Pump Filter

To replace the pump filter, refer to [Figure 7](#), and the following steps 1-8.

### Note

*If using the auxiliary filter on an older model pump module or as an additional filtration system on the new pump module, refer to [Attaching the Auxiliary Filter](#).*

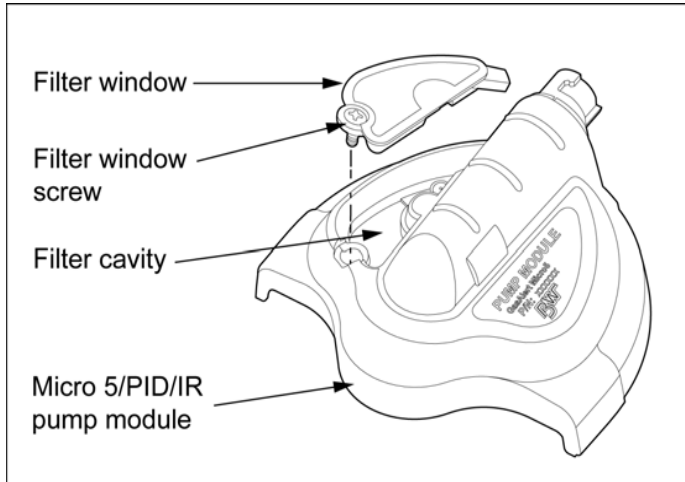

**Figure 7. Replacing the Pump Filter**

1. Deactivate the detector.
2. Remove the filter window screw.
3. Remove the filter window.
4. Remove the old filter from the filter window.  
**Important!** Ensure the filter cavity and filter window are clean and free of debris.
5. Insert a new filter.
6. Replace the filter window and screw.
7. Activate the detector. The detector performs a pump test during the startup self-tests to verify the pump module is operating correctly.
8. To order additional filters, refer to [Replacement Parts and Accessories](#).

### ⚠ Caution

**Filters may need to be replaced more frequently in high particulate areas. BW Technologies by Honeywell recommends that the auxiliary filter be used as an additional filtration in high particulate areas.**



## Replacing the Pump Nozzle

To replace the pump nozzle, refer to [Figure 8](#), and step 1-4.

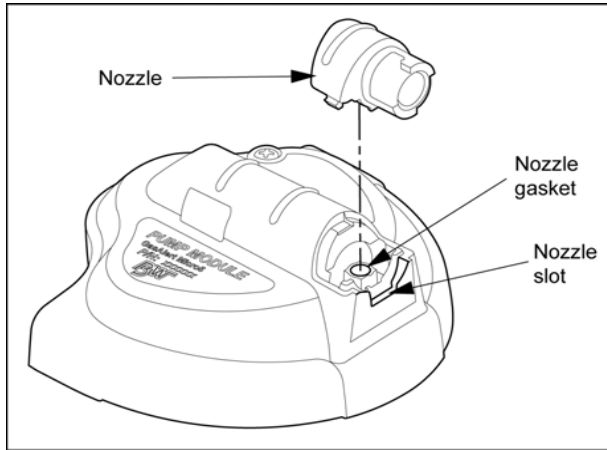

**Figure 8. Replacing the Pump Nozzle**

### Note

*If the nozzle is damaged, replace it immediately to ensure accurate pump flow. To order additional pump nozzles, refer to [Replacement Parts and Accessories](#).*

1. Deactivate the detector.
2. Gently insert a medium-sized flathead screwdriver into the nozzle slot. Twist the screwdriver slightly to lift and remove the damaged nozzle.

3. Insert the new nozzle. Ensure the nozzle post inserts correctly into the nozzle gasket.
4. Activate the detector. The detector performs a pump test during the startup self-tests to verify the pump module is operating correctly.

## Attaching the Auxiliary Filter

The Pump Module Auxiliary Filter (“the filter”) is used to filter out particulates that can decrease the life span of the pump.

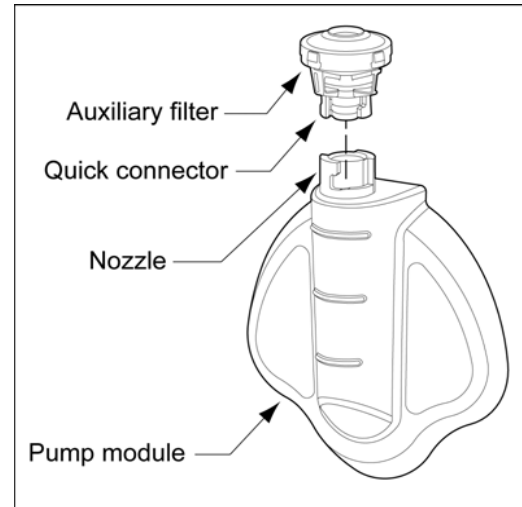

**Figure 9. Attaching the Auxiliary Filter**

**⚠ Caution**

The filter is designed to protect the pump. For older model pumps, the filter must be connected when the pump is activated. Only remove the filter to perform calibrations, bump tests, and when using the sample probe.

For new model pumps, the auxiliary filter can be used as an additional filtration system in high particulate areas.

To insert the auxiliary filter, complete the following:

1. Loop the filter cord through the ring on the alligator clip and pull the filter through the loop of the filter cord.

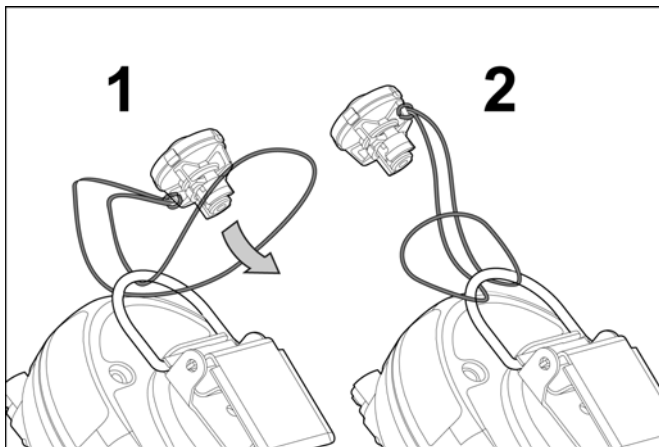

**Figure 10. Attaching the Filter Cord**

*Note*

*Attaching the filter cord to the alligator clip ensures the filter remains with the detector when not in use.*

2. Pull the filter cord tight. Ensure the loop knot is secure.
3. Align the pump quick connector with the filter quick connector and turn clockwise. Ensure the connection is secure.
4. Change the filter as required. Environments with heavy airborne particulates require the filter to be changed frequently.

To order additional filters, refer to [Replacement Parts and Accessories](#).

## Attaching the Sample Probe

The sample probe is used to safely test for gas in confined spaces before entering.

### **⚠ Warning**

**To measure hazardous gas in a confined space, the sample probe must be used with the pump module.**

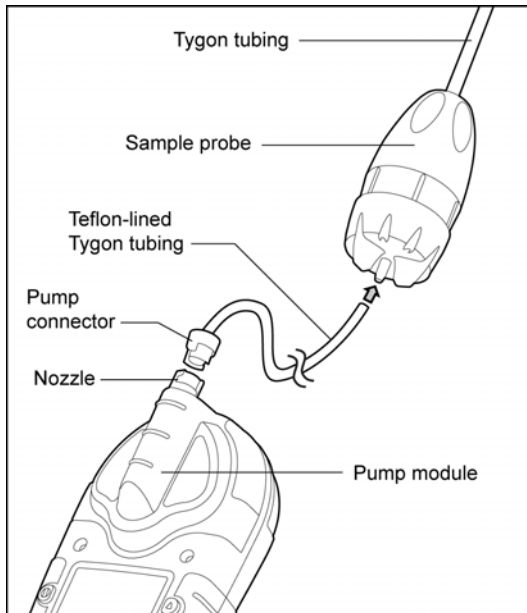

**Figure 11. Attaching the Sample Probe**

### **⚠ Caution**

**To prevent the Teflon lining inside the Tygon tubing from causing a blockage when connecting it to the sample probe, the end of the tubing must be flared. Refer to steps 3 and 4.**

1. Deactivate the detector.
2. Attach the pump connector end of the teflon-lined Tygon tubing to the nozzle on the pump module.
3. Gently insert needle nose pliers into the other end of the teflon-lined Tygon tubing. Using a circular motion, flare the end of the tubing.
4. Connect the flared end of the tubing to the sample probe. Ensure the teflon lining does not separate from the Tygon tubing, as it will block the tube and generate a pump alarm.
5. Activate the detector. Ensure all connections are secure before sampling.
6. Insert the sample probe into the confined space.

### **⚠ Warning**

**Depending upon the length of the tubing and the type of gas in the confined space, allow a minimum of 3 seconds per ft. of tubing to ensure the readings stabilize before entering the area.**

**Example: 50 ft. = 2.5 minutes**

### Datalogger

Detectors equipped with the datalogger option record information that can be compiled to create a report. To set how often the detector records a sample (1-127 seconds), refer to [Logger Option](#) in the user options menu.

The following information is recorded in a datalog:

- Date and time
- Serial number of the detector
- Type of gas the detector monitors
- Gas reading(s) that display
- STEL and TWA readings
- Sensor status
- Detector status
- Passcode protect enabled/disabled
- STEL period setting
- Confidence beep enabled/disabled
- Automatic backlight enabled/disabled
- Stealth mode is enabled/disabled
- Latching alarm enabled/disabled
- Calibration past due option enabled/disabled
- Language the detector is set to display

### MMC/SD Card Compatibility

#### ⚠ Caution

**To ensure the Intrinsic Safety rating of the detector, use only the following certified MultiMediaCards (MMC) and Secure Digital (SD) cards.**

The following MMCs and SD cards are approved for use with the GasAlertMicro 5 and GasAlertMicro 5 PID detectors:.

- 128 MB Delkin SD card
- 64 MB Unigen SD card

The following MMCs and SD cards are approved for use with the GasAlertMicro 5 and GasAlertMicro 5 PID detectors:.

- 128 MB Delkin MMC
- 128 MB Delkin SD card
- 128 MB Transcend MMC
- 64 MB Unigen SD card

To purchase additional MMC or SD cards, refer to [Specifications](#).

### Inserting the MMC/SD Card

To insert the MMC/SD card into the detector, refer to the following steps 1-5 and [Figure 12](#).

1. Deactivate the detector.
2. Release the latch and remove the battery pack.
3. Insert the MMC/SD card (pins face down).
4. Replace the battery pack and secure the latch.

5. Activate the detector. The MMC/SD card is automatically formatted during the startup self-test.

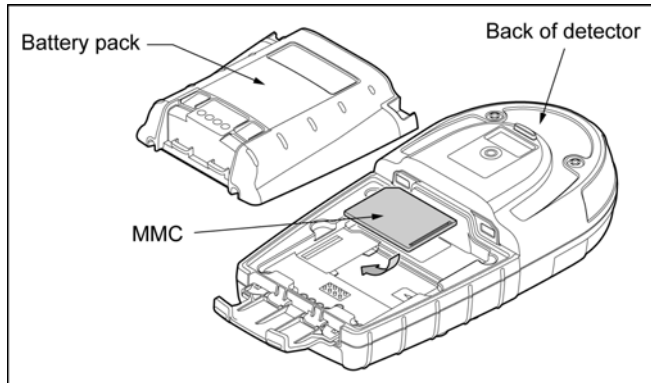

**Figure 12. Inserting/Removing the MMC/SD Card**

## **MMC/SD Card Troubleshooting**

The MMC/SD card is not required for operation in detectors equipped with datalogging. However, the following two screens display if the card is not inserted during startup.

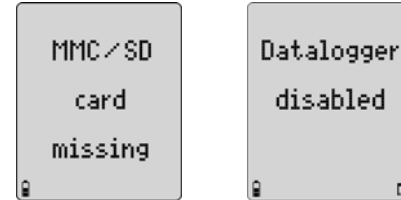

A new MMC/SD card is automatically formatted when it is inserted in the detector. When the detector is activated, it begins the self-test and then displays the following screen.

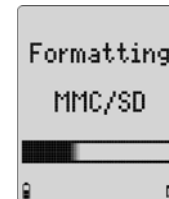

### Restoring Datalog Files

If the MMC/SD card has been accidentally reformatted or erased by the computer application, the following screens display when the card is inserted into the detector.



#### ⚠ Caution

**Only erased data files can be restored using the detector. Computer applications sometimes write data over erased files, and that erased data cannot be restored by the detector. Always create back up files on the computer.**

To restore the logfile, complete the following:

1. From the detector, press  to restore the logfile. The following screen displays.



If the detector successfully restores the logfile, the following screen displays and the startup tests continue.

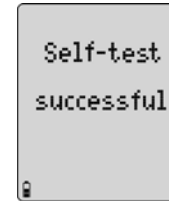

2. From the computer, verify that the logfile has been restored. When the normal operation screen displays, deactivate the detector.
3. Remove the MMC/SD card and insert it into the card reader.
4. From the computer desktop, double-click **My Computer** to view the list of drives.
5. Double-click the **Removable Disk** drive to access **LOGFILE0.csv**. Open the logfile and verify that the data has been restored.

If **LOGFILE0.csv** does not display, ensure that the MMC/SD card is inserted in the card reader correctly and that all connections are secure.

6. After verifying that the logfile has been restored, re-insert the MMC/SD card into the detector.

## **Reformatting the MMC/SD Card**

To reformat the MMC/SD card, complete the following:

1. Insert the MMC/SD card into the card reader.
2. From the computer desktop, double-click **My Computer** to view the list of drives.
3. Double-click the **Removable Disk** drive to access **LOGFILE0.csv**.
4. Select **LOGFILE0.csv** and delete.
5. Insert the MMC/SD card into the detector.
6. Activate the detector. The startup self-test begins and the following screens display.

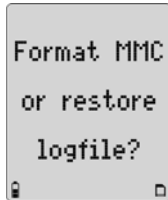
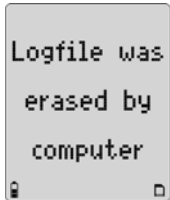

7. Press  $\blacktriangle$  to format the MMC/SD card. The following screen displays.



For any additional MMC/SD card errors, refer to [Troubleshooting](#).

## **Import Datalogs to Fleet Manager II**

### *Note*

*Refer to the following minimum requirements before importing datalogs to Fleet Manager II.*

### **Minimum PC Requirements**

- 500 MHz Pentium (or equivalent)
- 100 MB free hard disk space
- Windows XP or Vista
- USB port

### **Importing from MicroDock II to Fleet Manager II**

If the detector is used with the MicroDock II Station to import datalogs to Fleet Manager II, refer to the *MicroDock II User Manual* for complete instructions.

## **Import to Fleet Manager II Using a Card Reader**

To import a datalog file from the detector to Fleet Manager II, complete the following:

1. Deactivate the detector.
2. Release the latch and remove the battery pack.
3. Remove the MMC/SD card from the detector. Refer to [Figure 12](#), and [1](#).
4. Connect the card reader to the USB port on the computer.
5. Insert the MMC/SD card into the card reader (ensure the pins face down).
6. Open Fleet Manager II. Click **Start > All Programs > BW Technologies > Fleet Manager II > BW Technologies Fleet Manager II**.
7. From the top task bar, click **Help > User Manual**.
8. Refer to section “*Importing Data into Fleet Manager II*”.



## ***View Datalog Files in Spreadsheets***

The datalog files can be downloaded from the MMC/SD card into most spreadsheet applications using a card reader.

Compatible software applications are

- Microsoft® Excel 98 or higher,
- Quattro Pro,
- Lotus 1-2-3,
- Microsoft® Access, and
- Microsoft® Word.

To view a datalog file in a software spreadsheet, complete the following:

1. Deactivate the detector and remove the MMC/SD card (refer to [Figure 12.](#)).
2. Insert the MMC/SD card into the card reader.
3. From the computer desktop, double-click **My Computer** to view the list of drives.
4. Double-click **Removable Disk** drive.
5. Double-click **LOGFILE0.csv**.
6. Refer to [Table 15.](#) for an example of the datalog spreadsheet.

The Unit Config column (far right) in [Table 15.](#) contains letter codes. Refer to [Table 16.](#) and [Table 17.](#) for definitions of the codes.

*Example of a Datalog Spreadsheet*

When datalog information is imported into most spreadsheet software, it appears similar to the example below.

**⚠ Warning: Some compatible software packages have an internal file size limit and may not load the entire file. Check the software limit.**

*Note*

*Not all columns are included in this example. Additional Toxic TWA and Toxic STEL display on a normal spreadsheet.*

**Table 15. Datalog Spreadsheet Example**

Date dd-mm-yy	Day Mon=1	Time hh:mm:ss	Toxic1 ppm	Toxic2 ppm	Toxic3 ppm	LEL %CH4 %LEL	O2 %	Toxic 1 TWA ppm	Toxic 1 STEL ppm	Status Codes	Serial Number	Unit Config
23-12-05	#4	9:54:25	5	10	35			--	--	33-----	S104-000001	
23-12-05	#4	9:54:30	10	15	50			--	--	44-----	S104-000001	
23-12-05	#4	9:54:35	5	10	35	10	19.5	--	--	1111----	S104-000001	
23-12-05	#4	9:54:40	10	15	200	20	23.5	--	--	2222----	S104-000001	
23-12-05	#4	9:54:45	0	0	0	24	20.9	--	--	-D-E---D	S104-000001	FCEKNL
23-12-05	#4	9:54:50	0	0	0	24	20.9	0	0	-----	S104-000001	FCEKNL
23-12-05	#4	9:54:55	0	0	0	24	20.9	0	0	--L---L	S104-000001	FCEKNL
23-12-05	#4	9:55:00	0	0	0	24	20.9	0	0	LLH---M	S104-000001	FCEKNL
23-12-05	#4	9:55:05	5	10	35			0	0	LLH---M	S104-000001	
23-12-05	#4	9:55:10	10	15	50			0	0	LLL---M	S104-000001	
23-12-05	#4	9:55:15	5	10	35	10	19.5	0	0	-L----L	S104-000001	
23-12-05	#4	9:55:20	10	15	200	20	23.5	0	0	-----	S104-000001	
23-12-05	#4	9:55:25	0	0	0	24	20.9	0	0	-----B-	S104-000001	FCEKNL
23-12-05	#4	9:55:30	0	0	0	24	20.9	0	0	-----B-	S104-000001	FCEKNL

**Table 16. Datalog Status Codes**

<b>Status Codes</b>					
___	Normal operation	<b>G</b>	Backlight is on		
<b>L</b>	Low alarm	<b>v</b>	STEL and high alarm (dual alarms)	<b>1</b>	Alarm setpoint 1 (low alarm)
<b>H</b>	High alarm	<b>w</b>	TWA and STEL alarm (dual alarms)	<b>2</b>	Alarm setpoint 2 (high alarm)
<b>T</b>	TWA alarm	<b>x</b>	TWA, STEL, and low (triple alarms)	<b>3</b>	Alarm setpoint 3 (TWA alarm)
<b>U</b>	TWA and low alarm (dual alarms)	<b>y</b>	TWA, STEL, and high (triple alarms)	<b>4</b>	Alarm setpoint 4 (STEL alarm)
<b>V</b>	TWA and high alarm (dual alarms)	<b>O</b>	Overload / sensor is over-ranged	<b>D</b>	Calibration due date (days)
<b>s</b>	STEL alarm	<b>C</b>	Calibrating	<b>E</b>	Elapsed / last calibration (days)
<b>u</b>	STEL and low alarm (dual alarms)	<b>F</b>	Failure - sensor failure	<b>Z</b>	Auto zeroing
<b>f</b>	Fresh air delay	<b>I</b>	Time set	<b>t</b>	Testing
<b>@</b>	Zero CO <sub>2</sub>				
<b>Pump Codes</b>					
<b>P</b>	Plugged (blocked) - pump alarm	<b>F</b>	Failure / pump failure		
<b>Battery Status Codes</b>					
___	Batteries OK	<b>B</b>	Low battery alarm	<b>C</b>	Confidence beep is active
<b>Alarm Status Codes</b>					
<b>L</b>	Low alarm	<b>M</b>	Multi alarm	<b>S</b>	Automatic shutdown
<b>H</b>	High alarm	<b>C</b>	Calibration	<b>F</b>	Failure / self-test fail
<b>T</b>	TWA alarm	<b>Q</b>	Off / quit / manual deactivation	<b>R</b>	RTCC / real-time clock failure

Note: TWA readings greater than 99 are recorded as OL.

**Table 17. Datalog Gas and Correction Factor Sensor Codes**

<b>Gas Sensor Codes</b>									
<b>A</b>	No sensor	<b>B</b>	H <sub>2</sub> S	<b>C</b>	H <sub>2</sub> S COSH	<b>D</b>	CO	<b>E</b>	CO COSH
<b>F</b>	SO <sub>2</sub>	<b>G</b>	PH <sub>3</sub>	<b>H</b>	NO <sub>2</sub>	<b>I</b>	HCN	<b>J</b>	Cl <sub>2</sub>
<b>K</b>	NH <sub>3</sub>	<b>L</b>	ClO <sub>2</sub>	<b>M</b>	O <sub>3</sub>	<b>O</b>	LEL	<b>P</b>	PID
<b>Q</b>	IR								
<b>Correction Factor Codes for PID (if applicable)</b>									
<b>A</b>	Acetaldehyde	<b>B</b>	Acetone	<b>C</b>	Ammonia	<b>D</b>	Benzene	<b>E</b>	Butadiene
<b>F</b>	Diesel	<b>G</b>	Ethanol	<b>H</b>	Ethylene	<b>I</b>	Gasoline	<b>J</b>	Hexane
<b>K</b>	Isobtyln	<b>L</b>	JP8	<b>M</b>	Kerosene	<b>N</b>	MEK	<b>O</b>	Naptha
<b>P</b>	Styrene	<b>Q</b>	Toluene	<b>R</b>	Turpentine	<b>S</b>	Vinyl_Cl	<b>T</b>	Xylene
<b>U</b>	Custom								
<b>Correction Factor Codes for LEL</b>									
<b>A</b>	Acetone	<b>B</b>	Benzene	<b>C</b>	Butane	<b>D</b>	Cyclohexane	<b>E</b>	Ethanol
<b>F</b>	Ethyl_Ace	<b>G</b>	Gasoline	<b>H</b>	Heptane	<b>I</b>	Hexane	<b>J</b>	Hydrogen
<b>K</b>	Isobutylene	<b>L</b>	Isopropanol	<b>M</b>	MEK	<b>N</b>	Methane	<b>O</b>	Methanol
<b>P</b>	Octane	<b>Q</b>	Pentane	<b>R</b>	Propane	<b>S</b>	Toluene	<b>T</b>	Turpentine
<b>U</b>	Custom								
<b>LEL Unit Codes</b>									
<b>V</b>	LEL in % by Vol CH <sub>4</sub>			<b>L</b>	LEL in % LEL				

## Maintenance

To maintain the detector in good operating condition, perform the following basic maintenance as required.

- Calibrate, bump test, and inspect the detector at regular intervals.
- Maintain an operations log of all maintenance, calibrations, bump tests, and alarm events.
- Clean the exterior with a soft damp cloth. Do not use solvents, soaps, or polishes. Refer to [Sensor Poisons and Contaminants](#).
- Do not immerse the detector in liquids.

## Battery Cautions

### Warning

To avoid personal injury and/or property damage, adhere to the following:

- Replace the batteries immediately when the detector emits a low battery alarm.
- Use only batteries that are recommended by BW Technologies by Honeywell. Refer to [Specifications](#).
- Ensure the alkaline batteries are properly installed in the detector battery pack.
- Charge batteries using only a recommended BW charger. Do not use any other charger. Failure to adhere to this caution can cause fire and/or explosion.
- The detector must be deactivated to charge the battery.

- Do not calibrate the detector during or immediately after charging.
- Both the rechargeable lithium battery pack and the alkaline battery pack are user-changeable in hazardous locations, but the alkaline battery cells inside the pack can only be replaced in a safe area that is free of hazardous gas.
- **Warning:** The battery pack (M5-BAT08) that is equipped with a lithium polymer cell may present a risk of fire or chemical burn hazard if misused. Do not recharge, disassemble, heat above 212°F (100°C), or incinerate.
- **Warning:** Do not use any other lithium batteries with the Micro5/PID/IR detectors. Use of any other cell can cause fire and/or explosion. To order a replacement lithium battery pack (M5-BAT08), refer to [Replacement Parts and Accessories](#).
- **Warning:** Lithium Polymer cells exposed to heat at 266°F (130°C) for 10 minutes can cause fire and/or explosion.
- Dispose of used lithium cells immediately. Do not disassemble and do not dispose of in fire. Do not mix with the solid waste stream. Spent batteries must be disposed of by a qualified recycler or hazardous materials handler.
- Keep lithium cells away from children.

## Charging the Battery

To charge the battery, refer to the *GasAlertMicro 5/PID/IR Charger Instruction Sheet*.

### Replacing the Alkaline Batteries

To replace the alkaline batteries, refer to [Figure 13.](#), [Table 18.](#), and the following steps 1-6.

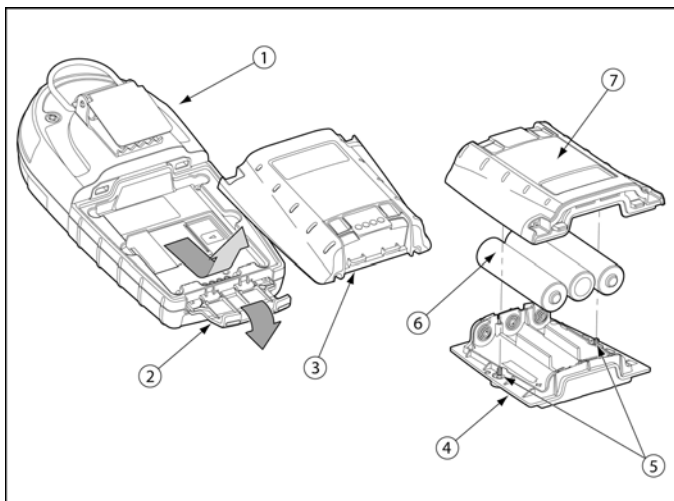

**Figure 13. Replacing the Alkaline Batteries**

**Table 18. Replacing the Alkaline Batteries**

Item	Description
1	Detector
2	Latch
3	Battery pack
4	Battery tray
5	Captive screws (2)
6	Alkaline batteries (3)
7	Battery shell

1. Open the latch on the bottom of the detector.
2. Remove the battery pack by lifting the bottom of the pack away from the detector.
3. On the battery pack, remove the two captive screws. Remove the battery shell from the battery tray.
4. Replace the three alkaline batteries.
5. Replace the battery pack and the captive screws.
6. Reinsert the battery pack and secure the latch.

### **Replacing the Lithium Battery Pack**

To replace the lithium battery pack, refer to [Figure 14](#), and the following steps 1-4.

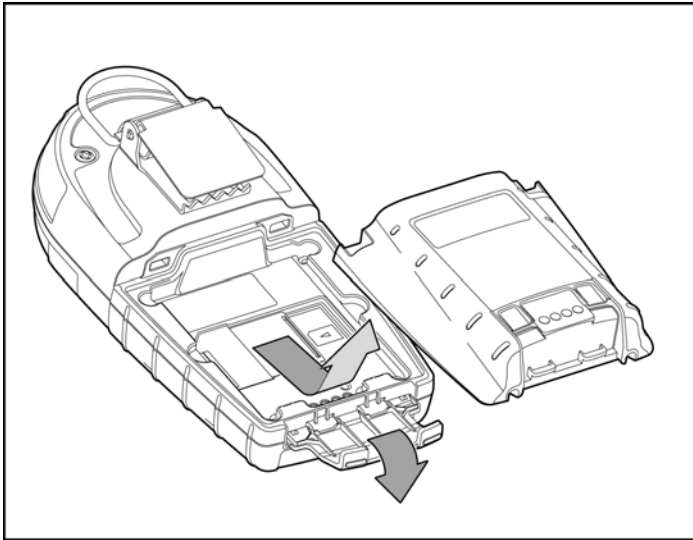

**Figure 14. Replacing the Lithium Battery Pack**

1. Open the latch on the bottom of the detector.
2. Remove the battery pack by lifting the bottom of the pack upward from the detector.

#### **⚠ Warning**

**Do not disassemble lithium battery packs. Read and adhere to the cautions in [Battery Cautions](#).**

3. Replace the battery pack with a fully charged lithium battery pack.
4. Close the latch.

### **Replacing a Sensor or Sensor Filter**

#### **⚠ Warning**

**To avoid personal injury, only use sensors that are specifically designed for the detector. Refer to [Specifications](#).**

Each sensor has a high degree of resistance to common vapors and gases. To clear a sensor, place the detector in a clean environment and wait 10 to 30 minutes.

Do not expose a sensor to vapors from organic solvents such as paint thinners and acetone. For a list of common products that can damage sensors, refer to [Sensor Poisons and Contaminants](#).

For sensor problems, refer to [Troubleshooting](#).

To replace a sensor or sensor filter, refer to [Figure 15.](#), [Table 19.](#), and the following procedures 1-7.

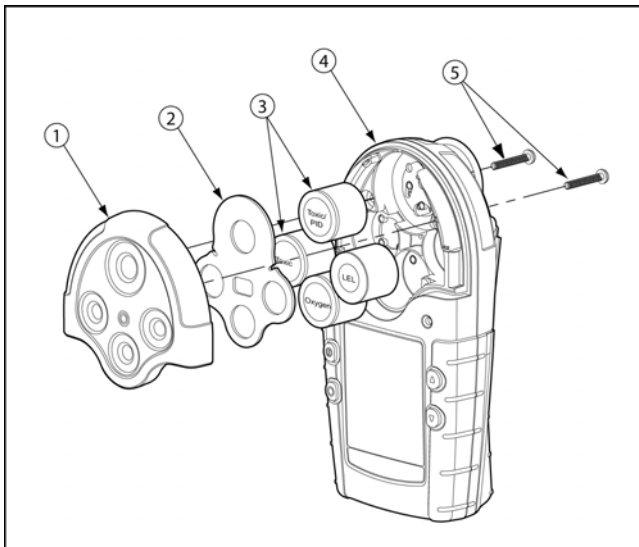

**Figure 15. Replacing a Sensor or Sensor Filter**

*Note*

*Detectors that are configured for 1, 2, 3, or 4 gases may contain a dummy sensor in one of the four sensor locations.*

**Table 19. Replacing a Sensor or Sensor Filter**

Item	Description
1	Sensor cover
2	Sensor filter
3	Sensors
4	Detector
5	Machine screws (2)

1. Deactivate the detector.
2. Remove the two machine screws on the rear shell and then remove the sensor cover or pump module.
3. Remove the sensor filter and/or the sensor(s).
4. Insert the new filter and/or sensor. Ensure the sensor posts are aligned correctly.
5. Re-assemble the detector.
6. If the sensor is changed, such as SO<sub>2</sub> to an H<sub>2</sub>S, the detector must be reconfigured. Refer to [Sensors](#) in the [Tech Mode](#) option.
7. A sensor that has been replaced must be calibrated immediately. Refer to [Calibration and Setting Alarm Setpoints](#).



## Photoionization Detector (PID)

### Clean or Replace the Lamp

The PID lamp must be cleaned regularly. Use only the cleaning kit that is supplied by BW Technologies by Honeywell.

To clean the PID lamp, refer to the illustrations and procedures that are provided with the *PID Lamp Cleaning Kit*. To order the kit, refer to [Replacement Parts and Accessories](#).

#### **⚠ Caution**

**To ensure proper maintenance and continued accurate readings from the sensor, use only the PID Lamp Cleaning Kit that is supplied by BW Technologies by Honeywell.**

**Table 20. Parts of the PID sensor**

Item	Description
1	PID sensor
2	Diffusion barrier
3	Sensor cover
4	Electrode stack
5	Lamp

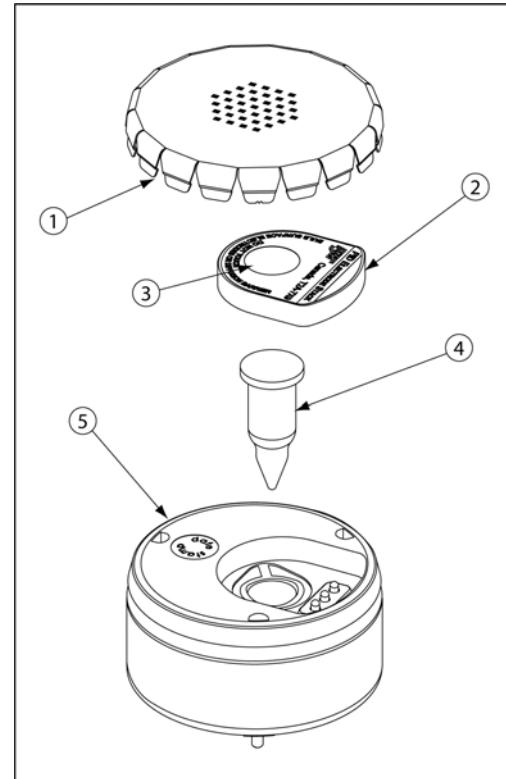

**Figure 16. Parts of the PID**

### *Replace the Lamp*

Replace the lamp when it falls below the acceptable level. Possible indicators that the lamp requires replacement are as follows:

- The detector will not calibrate.
- The startup self-test fails.
- The ppm levels are incorrect.

To replace the lamp, refer to the illustrations and procedures in the *PID Lamp Cleaning Kit*.

If required, contact [BW Technologies by Honeywell](#) for more information.

### *Replace the Electrode Stack*

Replace the electrode stack when it is contaminated. To replace the electrode stack, refer to [Table 20](#), [Figure 16](#), and the following procedures. 1-4.

#### **⚠ Caution**

**Ensure your fingers do not make contact with the diffusion barrier or the electrodes on the underside of the stack.**

1. Remove the sensor cover.
2. Remove the old electrode stack.
3. Insert the new electrode stack.
4. Replace the sensor cover.

## Troubleshooting

If a problem occurs, refer to the solutions provided in [Table 21](#). If the problem persists, contact [BW Technologies by Honeywell](#).



**Table 21. Troubleshooting**

Problem	Possible Cause	Solution
<b>Startup Troubleshooting</b>		
The detector does not activate.	No batteries	Refer to <a href="#">Replacing the Alkaline Batteries</a> or <a href="#">Replacing the Lithium Battery Pack</a> .
	Depleted batteries	Refer to <a href="#">Replacing the Alkaline Batteries</a> , or <a href="#">Replacing the Lithium Battery Pack</a> .
	Damaged or defective detector	Contact <a href="#">BW Technologies by Honeywell</a> .
The detector immediately enters alarm mode when activated.	Sensor needs to stabilize	Used sensor: wait 60 seconds. New sensor: wait 5 minutes.
	Low battery alarm	Refer to <a href="#">Battery Cautions</a> , <a href="#">Replacing the Alkaline Batteries</a> , <a href="#">Replacing the Lithium Battery Pack</a> .
	Sensor alarm	Refer to <a href="#">Replacing a Sensor or Sensor Filter</a> .
	Pump alarm	If the sampling hose is attached, determine if it is obstructed. If not, clean or replace the pump filter. If the pump alarm persists, refer to the "Pump Operation" section in Troubleshooting.
The startup self-test fails.	General fault	Ensure that the sensors and battery pack are installed correctly and then reactivate the detector.  If the fault persists, record the error message and contact <a href="#">BW Technologies by Honeywell</a> .

**Table 21. Troubleshooting**

<b>Problem</b>	<b>Possible Cause</b>	<b>Solution</b>
<b>Detector Operation Troubleshooting</b>		
Detector does not display normal ambient gas readings after startup self-test.	Sensor not stabilized	Used sensor: wait 60 seconds New sensor: wait 5 minutes
	Detector requires calibration	Calibrate the sensors. Refer to <a href="#">Calibration and Setting Alarm Setpoints</a> .
	Target gas is present	Detector is operating properly. Use caution in suspect areas.
Detector does not respond to pushbuttons.	Batteries are depleted	Refer to <a href="#">Replacing the Alkaline Batteries</a> or <a href="#">Replacing the Lithium Battery Pack</a> .
	Detector is performing operations that do not require user input	Pushbutton function restores automatically when the operation ends.
Detector does not accurately measure gas.	Detector requires calibration	Calibrate the sensors. Refer to <a href="#">Calibration and Setting Alarm Setpoints</a> .
	Detector is colder/hotter than ambient gas	Allow the detector to adjust to ambient temperature before using.
	Sensor filter is blocked	Clean the sensor filter. Refer to <a href="#">Replacing a Sensor or Sensor Filter</a> .

Table 21. Troubleshooting

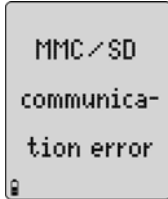
Problem	Possible Cause	Solution
<b>MMC/SD Card Troubleshooting</b>		
 <p>MMC/SD card missing</p>	<p>The MMC/SD card is not inserted.</p>	<p>Insert the MMC/SD card. Refer to <a href="#">Inserting the MMC/SD Card</a>.</p>
 <p>MMC/SD size not supported</p>	<p>The MMC/SD card that is inserted in the detector has a storage size that is not supported by the detector.</p>	<p>Insert an approved MMC/SD card:</p> <ul style="list-style-type: none"> <li>• 128 MB Delkin MMC</li> <li>• 128 MB Delkin SD card</li> <li>• 128 MB Transcend SD card</li> <li>• 64 MB Unigen SD card</li> </ul>
 <p>MMC/SD communica- tion error</p>	<p>The detector has lost communication with the MMC/SD card.</p>	<p>Retry communication</p> <p>Insert a new approved MMC or SD card. Refer to <a href="#">Inserting the MMC/SD Card</a>.</p> <p>Reformat the MMC or SD card in windows and then reinsert into the detector.</p> <p>Contact <a href="#">BW Technologies by Honeywell</a>.</p>

**Table 21. Troubleshooting**

<b>Problem</b>	<b>Possible Cause</b>	<b>Solution</b>
<b>Alarms Troubleshooting</b>		
Detector does not enter alarm mode.	Alarm setpoint(s) are set incorrectly.	Reset alarm setpoints. Refer to <a href="#">Calibration and Setting Alarm Setpoints</a> .
	Alarm setpoint(s) are set to zero.	Reset alarm setpoints. Refer to <a href="#">Calibration and Setting Alarm Setpoints</a> .
	Detector requires calibration.	Calibrate the sensors. Refer to <a href="#">Calibration and Setting Alarm Setpoints</a> .
Detector intermittently enters alarm without any apparent reason.	Ambient gas levels are near alarm setpoint or the sensor is exposed to a puff of the target gas.	Detector is operating normally. Use caution in suspect areas. Check MAX gas exposure reading.
	Alarms setpoints are set incorrectly.	Reset alarm setpoints. Refer to <a href="#">Calibration and Setting Alarm Setpoints</a> .
	Missing or faulty sensor.	Refer to <a href="#">Replacing a Sensor or Sensor Filter</a> .
Detector enters alarm with LEL reading displaying as <b>OL</b> (over limit).	Pump flow rate is set too high.	Refer to the last solution in <b>Pump Operation</b> troubleshooting on the following page.
<b>Automatic Deactivation Troubleshooting</b>		
Detector automatically deactivates.	Automatic shutdown activated because of weak batteries.	Refer to <a href="#">Charging the Battery</a> .
	Calibration is overdue and the <b>Due-lock</b> (calibration user lock-out) option is enabled.	Enter the password to enter calibration. Calibrate the sensor(s). Refer to <a href="#">Calibration Procedure</a> .

**Table 21. Troubleshooting**

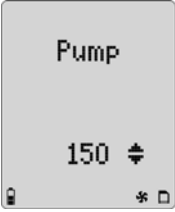
Problem	Possible Cause	Solution
<b>Pump Operation Troubleshooting</b>		
	There is an obstruction in the tubing.	If using tubing that is attached to the sample probe, determine if it is obstructed. If not, clean or replace the pump filter. Refer to <a href="#">Replacing the Pump Filter</a> .
	Filter needs to be cleaned or replaced.	Clean or replace the pump filter. Refer to <a href="#">Replacing the Pump Filter</a> .
	Pump is drawing too much air over the sensors.	For newer model pump modules, the pump may be drawing too much air over the sensors. Attach the auxiliary filter to reduce the flow. Refer to <a href="#">Attaching the Auxiliary Filter</a> .
Detector enters alarm with LEL reading displaying as over limit (OL).	Pump flow rate is set too high.	<ol style="list-style-type: none"> <li>From <a href="#">Tech Mode</a>, scroll to the <b>Pump</b> option and press ○.</li> <li>From the Pump Speed screen, press ▼ to decrease the speed to <b>150</b>.</li> </ol> <div style="text-align: center;">  </div> <ol style="list-style-type: none"> <li>Exit user options. The detector automatically initiates a pump test.</li> <li>If the pump alarm persists, contact <a href="#">BW Technologies by Honeywell</a>.</li> </ol>

**Table 21. Troubleshooting**

<b>Problem</b>	<b>Possible Cause</b>	<b>Solution</b>
<b>Clock Errors Troubleshooting</b>		
Clock icon is flashing.	The clock has failed.	Contact <a href="#">BW Technologies by Honeywell</a> .
	There is communication failure.	Contact <a href="#">BW Technologies by Honeywell</a> .
The detector displays a clock error message using last recorded time.	General fault.	Reactivate the detector. If the same error message displays, reset the clock in the user options menu. Reactivate the detector. If the error message still displays, contact <a href="#">BW Technologies by Honeywell</a> .



## Replacement Parts and Accessories

### ⚠ Warning

To avoid personal injury and/or damage to the detector, use only the specified replacement parts.

To order parts or accessories, contact [BW Technologies by Honeywell](#).

**Table 22. Replacement Parts and Accessories**

Model No.	Description	Qty
<b>Sensors</b>		
S4-W04	Combustible (LEL) sensor (with silicone protection filter)	1
S4-W04-UF	Combustible (LEL) sensor (no silicone protection filter)	1
SR-X10	Oxygen (O <sub>2</sub> ) sensor	1
PS-RM04	Carbon monoxide (CO) sensor	1
PS-RH04S	Hydrogen sulfide (H <sub>2</sub> S) sensor	1
SR-P04	Phosphine (PH <sub>3</sub> ) sensor	1
PS-RS04	Sulfur dioxide (SO <sub>2</sub> ) sensor	1
PS-RC10	Chlorine (Cl <sub>2</sub> ) sensor	1
SR-A04	Ammonia (NH <sub>3</sub> ) sensor	1
PS-RD04	Nitrogen dioxide (NO <sub>2</sub> ) sensor	1
PS-RZ10	Hydrogen cyanide (HCN) sensor	1
SR-V04	Chlorine dioxide (ClO <sub>2</sub> ) sensor	1
SR-G04	Ozone (O <sub>3</sub> ) sensor	1
D4-RHM04	TwinTox CO/H <sub>2</sub> S sensor	1

SR-Q07	PID sensor	1
SR-B04	Carbon dioxide (CO <sub>2</sub> ) sensor	1
SR-DUMM1	Dummy sensor 3-pin O <sub>2</sub> or TwinTox	1
SR-DUMM2	Dummy sensor for LEL location	1
<b>Sensor Replacement Parts and Accessories</b>		
RL-PID10.6	Lamp for PID sensor	1
M5PID-ES-1	Electrode stack for PID sensor	2
M5PID-CLN-K1	Cleaning kit for PID sensor lamp	1
M5-SS	Sensor filters (quad) kit of 2	2
<b>Gas Cylinders</b>		
CG-Q58-4	Quad calibration gas, CH <sub>4</sub> -2.5%, O <sub>2</sub> -18.0%, H <sub>2</sub> S-25 ppm, CO-100 ppm, bal. N <sub>2</sub> (58 l)	1
CG-Q34-4	Quad calibration gas, CH <sub>4</sub> -2.5%, O <sub>2</sub> -18.0%, H <sub>2</sub> S-25 ppm, CO-100 ppm, bal. N <sub>2</sub> (34 l)	1
CG-T34	Two gas calibration cylinder, 50% LEL (CH <sub>4</sub> -2.5%) O <sub>2</sub> -20.9%, bal. N <sub>2</sub> (34 l)	1
CG2-S-25-58	Calibration gas, SO <sub>2</sub> 25 ppm (58 l)	1
CG-BUMP-S25	SO <sub>2</sub> bump test gas	1
CG-BUMP1	Bump alarm gas aerosol (CH <sub>4</sub> -2.5%, O <sub>2</sub> -10%, H <sub>2</sub> S-40 ppm, CO-200 ppm)	1
REG-0.5	Regulator (0.5 l/min)	1
G0042-H25	Calibration gas, H <sub>2</sub> S 25 ppm (58 l)	1

# GasAlertMicro 5/PID/IR

## User Manual

CG2-M-200-103	Calibration gas, CO 200 ppm (103 l)	1
CG2-S-25-58	Calibration gas, SO <sub>2</sub> 25 ppm (58 l)	1
CG2-C-5-58	Calibration gas, Cl <sub>2</sub> 5 ppm (58 l)	1
CG2-Z-10-58	Calibration gas, HCN 10 ppm (58 l)	1
CG2-D-10-58	Calibration gas, NO <sub>2</sub> 10 ppm (58 l)	1
CG2-P-1-58	Calibration gas, PH <sub>3</sub> 1 ppm (58 l)	1
CK-Q34-4	Quad calibration kit with regulator, quad gas cylinder (CG-Q34-4), hose and carrying case	1
CK-Q58-4	Quad calibration kit with regulator, quad gas cylinder (CG-Q58-4), hose and carrying case	1
<b>Micro 5/PID/IR Alkaline Battery Packs</b>		
M5-BAT0501	Alkaline battery pack	1
M5-BAT0502	Alkaline battery pack with European screw	1
<b>Micro 5/PID/IR Lithium Battery Packs</b>		
M5-BAT08	Lithium rechargeable battery pack	1
M5-BAT08B	Lithium rechargeable battery pack (black)	
<b>Micro 5/PID/IR Chargers and Kits</b>		
M5-CO1*	GasAlertMicro 5 battery charger	1
M5-CO1-BAT08*	GasAlertMicro 5 Lithium battery charger and battery pack kit	1
GA-V-CHRG4	Vehicle GasAlertMicro 5 battery charger	1
M5-BL-1	Battery latch replacement	1

<b>Datalogger Accessories</b>		
CR-MMC-USB1	USB memory card reader	1
MMC128-D	128 MB Delkin MMC	1
MMC128-D	128 MB Delkin SD card	1
MMC128-D	128 MB Transcend SD card	1
M5-MMC	64 MB Unigen SD card	1
<b>Accessories</b>		
M5-PUMP	Motorized Pump Module Kit	1
M5-TC-1	Calibration cap and hose	1
GA-AG-2	Alligator clip (stainless steel)	1
GA-CH-2	Chest harness	1
GA-ES-1	Extension strap	1
GA-ARM-1	Arm band	1
GA-HM5	Belt holster	1
<b>Replacement Parts</b>		
	Pump replacement filters (kit of 2)	1
	Pump replacement filters (kit of 5)	1
	Pump replacement nozzle (kit of 2)	1

\* Add suffix (-UK) for United Kingdom mains plug, (-EU) for European mains plug, (-AU) for Australian mains plug.

## **Specifications**

**Instrument dimensions:** 14.5 x 7.4 x 3.8 cm (5.7 x 2.9 x 1.5 in.)

**Weight:** 370 g (13.1 oz.)

### **Operating and storage conditions**

#### **Temperature:**

VOC: -10°C to +40°C (-14°F to +104°F)

Other gases: -20°C to +50°C (-4°F to +122°F)

Combustible gas sensor: Certified by CSA International to ±3% LEL accuracy from -10°C to +40°C (4°F to 104°F)

#### **Humidity:**

O<sub>2</sub>: 0% to 99% relative humidity (non-condensing)

VOC and CO<sub>2</sub> IR: 0% to 95% relative humidity (non-condensing)

Combustibles: 5% to 95% relative humidity (non-condensing)

Cl<sub>2</sub>: 10% to 95% relative humidity (non-condensing)

HCN, ClO<sub>2</sub>: 15% to 95% relative humidity (non-condensing)

Other gases: 15% to 90% relative humidity (non-condensing)

**Pressure:** 95 to 110 kPa

**Alarm setpoints:** May vary by region and are user-defined

#### **Detection range:**

O<sub>2</sub>: 0 – 30.0% vol. (0.1% vol. increments)

CO: 0 – 999 ppm (1 ppm increments)

CO (TwinTox sensor): 0 – 500 ppm (1 ppm increments)

H<sub>2</sub>S: 0 – 500 ppm (1 ppm increments)

H<sub>2</sub>S (TwinTox sensor): 0 – 500 ppm (1 ppm increments)

Combustible (LEL): 0 - 100% LEL (1% LEL increments) or 0 - 5.0% v/v methane; certified by CSA International to C22.2 No. 152 and ISA 12.13.01 within 0 - 60% or 3.0% v/v methane

PH<sub>3</sub>: 0 – 5.0 ppm (0.1 ppm increments)

SO<sub>2</sub>: 0 – 150 ppm (1 ppm increments)

Cl<sub>2</sub>: 0 – 50.0 ppm (0.1 ppm increments)

NH<sub>3</sub>: 0 – 100 ppm (1 ppm increments)

NO<sub>2</sub>: 0 – 99.9 ppm (0.1 ppm increments)

HCN: 0 – 30.0 ppm (0.1 ppm increments)

ClO<sub>2</sub>: 0 – 1.00 ppm (0.01 ppm increments)

O<sub>3</sub>: 0 – 100 ppm (0.01 ppm increments)

VOC: 0 – 1000 ppm (1.0 ppm increments)

CO<sub>2</sub> IR: 0-50,000 ppm (50 ppm increments) or 0-5.0% v/v CO<sub>2</sub>

(Sensors not available for use with the Micro 5 IR: ClO<sub>2</sub>, HCN, NO<sub>2</sub>, PH<sub>3</sub>, and Cl<sub>2</sub>)

#### **Sensor type:**

H<sub>2</sub>S/CO: Twin plug-in electrochemical cell

Combustibles: Plug-in catalytic bead

VOC: Photoionization detector (PID)

CO<sub>2</sub>: IR detector

Other gases: Single plug-in electrochemical cell

**O<sub>2</sub> measuring principle:** Capillary controlled concentration sensor

**Alarm conditions:** TWA alarm, STEL alarm, low alarm, high alarm, multi alarm, over limit alarm, sensor alarm, pump alarm, MMC/SD card fail alarm, low battery alarm, confidence beep, automatic deactivation alarm

**Audible alarm:** 95 dB at 0.3 m (1 ft.) variable pulsed dual beepers

**Visual alarm:** Dual red light-emitting diodes (LED)

**Display:** Alphanumeric liquid crystal display (LCD)

## GasAlertMicro 5/PID/IR

### User Manual

---

**Backlight:** Automatically activates during an alarm condition and when there is insufficient light to view the LCD (if enabled in user options)

**Self-test:** Initiated during activation

**Calibration:** Automatic zero and automatic span

**Oxygen sensor:** Automatic span upon activation (enable/disable option)

**User options:** Confidence beep, latching alarms, passcode protection, enable/disable safe display mode, combustible sensor measurement, sensor disable, TWA and STEL, language selection, enable/disable automatic oxygen calibration, define span concentration values, define STEL calculation period, define TWA method, gas measurement resolution, enable/disable automatic backlight, adjust clock calendar, and define logging rate (datalogger models only), CO<sub>2</sub> sensor measurement

#### Approved MMC and SD cards for GasAlertMicro 5 and

**GasAlertMicro 5 PID:** 128 MB Delkin SD card and 64 MB Unigen SD card

**Approved MMC and SD cards for GasAlertMicro 5 IR:** 128 MB Delkin MMC, 128 MB Delkin SD card, 128 MB Transcend MMC, and 64 MB Unigen SD card

#### Battery operating time:

**Toxic, O<sub>2</sub>, and LEL sensors:** Three alkaline cells or one lithium battery pack at 20°C provides 20 hours operating runtime

**Toxic, O<sub>2</sub>, LEL, and PID sensors:** Three alkaline cells or one lithium battery pack at 20°C provides 15 hours operating runtime

**Toxic, O<sub>2</sub>, LEL, and CO<sub>2</sub> sensors:** Three alkaline cells or one lithium battery pack at 20°C provides 15 hours operating runtime

**Year of manufacture:** The detector's year of manufacture is determined from the serial number. The second and third number after the first letter determines the year of manufacture.

E.g., H309-Y000001 = 2009 year of manufacture

#### Approved batteries for GasAlertMicro 5/PID/IR models:

Alkaline (M5-BAT02) and lithium-ion polymer (M5-BAT08), as per standards EN 60079-11, EN 60079-0, UL913, CSA C22.2 No.157

#### Alkaline:

Duracell MN1500      -20°C ≤ Ta ≤ +50°C

Energizer E91VP      -20°C ≤ Ta ≤ +50°C

#### Temperature Code

T4 (129.9°C)

T3C (135.3°C)

#### Lithium rechargeable:

M5-BAT08      -20°C ≤ Ta ≤ 50°C

T4

**Battery charger:** GasAlertMicro 5/PID/IR battery charger

**First-time charge:** 6 hours for lithium battery pack

**Normal charge:** 6 hours for lithium battery pack

**Warranty:** 2 years including sensors  
(1 year for NH<sub>3</sub> sensor and PID lamp)

**Approvals:**

**GasAlertMicro 5 and GasAlertMicro 5 PID (Zone 0)**

Approved by CSA to both U.S. and Canadian Standards

**Standards:** CAN/CSA C22.2 No. 157 and C22.2 No.152  
ANSI/UL – 913 and ANSI/ISA – S12.13 Part 1

**CSA** Class I, Division 1, Group A, B, C, and D  
Class 1, Zone 0, Group IIC

**ATEX** CE 0539 Ⓢ II 1 G Ga Ex ia IIC T4  
KEMA 06 ATEX 0206X

EN 60079-0, EN 60079-11, EN 60079-26

**IECEX** Ga Ex ia IIC IECEX CSA 06.0011X  
IEC 60079-0, IEC 60079-11, IEC 60079-26

**ABS Type Approved:** VA-348169-X

**GasAlertMicro 5 IR (Zone 1):**

Approved by CSA to both U.S. and Canadian Standards

**Standards:** CAN/CSA C22.2 No. 157 and C22.2 No.152  
ANSI/UL – 913 and ANSI/ISA – S12.13 Part 1

**CSA** Class I, Division 1, Group A, B, C, and D  
Class 1, Zone 1, Group IIC

**ATEX** CE 0539 Ⓢ II 2 G Ex d ia IIC  
KEMA 06 ATEX 0206X

EN 60079-0, EN 60079-1, EN 60079-11

**IECEX** Ex d ia IIC IECEX CSA 06.0011X  
IEC 60079-0, IEC 60079-1, IEC 60079-11

This equipment has been tested and found to comply with the limits for a Class B digital device, pursuant to Part 15 of the FCC Rules and ICES-003 Canadian EMI requirements. These limits are designed to provide reasonable protection against harmful interference in a residential installation. This equipment generates, uses and can radiate radio frequency energy and, if not installed and used in accordance with the instructions, may cause harmful interference to radio communications. However, there is no guarantee that interference will not occur in a particular installation. If this equipment does cause harmful interference to radio or television reception, which can be determined by turning the equipment off and on, the user is encouraged to try to correct the interference by one of more of the following measures:

- Reorient or relocate the receiving antenna.
- Increase the separation between the equipment and receiver.
- Connect the equipment into an outlet on a circuit different from that to which the receiver is connected.
- Consult the dealer or an experienced radio/TV technician for help.

#### **General Specifications for Datalogger Units**

**Media type:** MultiMediaCard (MMC) or Secure Digital (SD) card

**Approved MMC and SD cards for GasAlertMicro 5 and**

**GasAlertMicro 5 PID:** 128 MB Delkin SD card and 64 MB Unigen SD card

**Approved MMC and SD cards for GasAlertMicro 5 IR:** 128 MB Delkin MMC, 128 MB Delkin SD card, 128 MB Transcend MMC, and 64 MB Unigen SD card

**Storage:** 500,000 lines of data available; 4.4 months at 5 second intervals (based on a normal work week)

**Memory type:** Wrap-around memory ensures most recent data is always saved

**Sample rate:** One reading every 5 seconds (standard)

**Data recorded:** All sensor readings, all alarm conditions, calibrations, event flags, battery status, pump status, sensor status, confidence beep activation, and detector status that includes the date, time and detector serial number for each reading

**MMC/SD card test:** Automatically during activation

#### **GasAlertMicro 5/PID/IR Downloadable Datalogger**

**Operation:** Requires no user intervention (automatic)

**Indicators:** Icon indicates datalogger is operating normally, MMC/SD card missing/malfunction

**Compatibility:** Desktop PC or laptop

**Operating system:** Windows 95 or higher and Macintosh OS 8.6 or higher

**Download via:** MMC/SD reader

**Software required:** Spreadsheet or database compatible with comma-separated-value (CSV) text files

**Card alarm:** Card fail or missing

#### **Support:**

**Fleet Manager II:** Reports are generated using the detector datalogs and the Fleet Manager II application. Filters can be defined using Fleet Manager II, or data can be exported to Excel for custom reports.

#### **Software Requirements to generate reports:**

- Windows XP or Vista
- Fleet Manager II
- Excel (optional)

**PID Correction Factor (CF) Library**

**Table 23. PID Corrections Factor (CF) Library**

Gas #	Gas Type	LCD Gas Type Abbreviation	Correction Factor Value (CF values subject to change)
1	No PID correction factor	N/A	N/A
2	Acetaldehyde	Acetdhd	4.6'
3	Acetone	Acetone	1.2'
4	Ammonia	Ammonia	10.6'
5	Benzene	Benzene	0.5'
6	Butadiene	Butadien	0.9'
7	Diesel	Diesel	0.9'
8	Ethanol	Ethanol	13.3'
9	Ethylene	Ethylene	9.1'
10	Gasoline	Gasoline	0.7'
11	Hexane	Hexane	4.6'
12	Isobtyln	Isobtyln	1.0'
13	JP8	JP-8	0.5'
14	Kerosene	Kerosene	1.1'
15	MEK	MEK	0.9'
16	Naptha	Naptha	1.0'
17	Styrene	Styrene	0.5'
18	Toluene	Toluene	0.5'
19	Turpentine	Turpentine	0.5'
20	Vinyl Chloride	Vinyl Chloride	2.2'
21	Xylene	Xylene	0.5'
22	Custom	Custom	0.1' to 15.0'





**Wear yellow. Work safe.**

iERP: 128900

D5615/5 [English]

© BW Technologies 2009. All rights reserved.